

ISSUE 3

# Replacement Medical Battery Range



REPLACEMENT MEDICAL BATTERIES  
SEALED LEAD ACID BATTERIES  
PRIMARY & RECHARGEABLE BATTERIES  
CHARGERS, ANALYSERS & PRINTERS

# How to use this brochure

<b>PANASONIC (a)</b> <b>LCR-127R2P1 (b)</b> Part No: 04224 (c) 12.0V/7200mAh (d) VRLA - AGM (e) 151 x 64.5 x 94 / 100mm (f) Weight: 2470g (g) Terminal: 4D (h)	
---	---

Product Reference\*:

- (a) Manufacturer Name
- (b) Model of Equipment or Battery
- (c) Part Number
- (d) Voltage and Capacity of Battery (if available)
- (e) Battery Chemistry
- (f) \*\*Dimensions are L x W x H / H to Top of Terminals (if available)
- (g) Weight of Battery
- (h) Terminal details (Sealed Lead Acid Batteries section only)

\* Excludes Chargers, Analysers & Printers section

\*\* Some batteries have dimensions of diameter and height. This is signified by (Dia. x H)

---

## Contents

Page No.

REPLACEMENT MEDICAL BATTERIES	3
SEALED LEAD ACID BATTERIES	44
PRIMARY & RECHARGEABLE BATTERIES	52
CHARGERS, ANALYSERS & PRINTERS	54
BATTERY TERMINAL & LAYOUT INFORMATION	55
INDEX	56

# REPLACEMENT MEDICAL BATTERIES

3M - ABBOTT LABORATORIES / HOSPIRA / ROSS

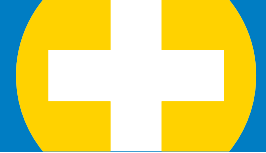

**3M**

**100 / 110 / 200 / 200A / 210 / 270 / 285 / 300**

Part No: 04202  
6.0V/3800mAh VRLA - AGM  
66 x 33 x 118 / 126mm  
Weight: 735g



**ABBOTT LABORATORIES / HOSPIRA / ROSS**

**Flexi Flo Portable Nutrient Pump**

Part No: 04110  
6.0V/1000mAh VRLA - AGM  
51 x 42.5 x 51 / 54.5mm  
Weight: 250g



**3M**

**9661 Surgical Clipper**

Part No: CSA20023  
1.2V/3000mAh Ni-MH  
(Dia.x H): 23 x 43mm  
Weight: 57g

CE



**ABBOTT LABORATORIES / HOSPIRA / ROSS**

**Flexiflo Quantum**

Part No: 04278  
8.0V/3200mAh VRLA - AGM  
134 x 36 x 66 / 69mm  
Weight: 860g



**3M**

**Surgical Clipper 9671 (with Tags)**

Part No: CSB01033  
1.2V/2700mAh Ni-MH  
(Dia.x H): 16.7 x 48.8mm  
Weight: 40g



**ABBOTT LABORATORIES / HOSPIRA / ROSS**

**Gemstar Docking Station**

Part No: EE090240  
2.4V/3600mAh Ni-MH  
70 x 18 x 136mm  
Weight: 120g

CE

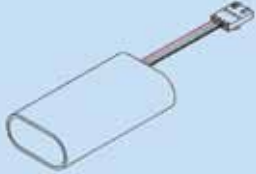

**3M**

**Surgical Shaver (Contact fitting)**

Part No: EE120378  
1.2V/1900mAh Ni-Cd  
(Dia.x H): 23 x 43mm  
Weight: 52g



**ABBOTT LABORATORIES / HOSPIRA / ROSS**

**Gemstar Infusion Pump (send for rebuild)**

Part No: CSA14022  
3.7V/4400mAh Lithium Rechargeable  
203 x 37 x 21mm  
Weight: 100g

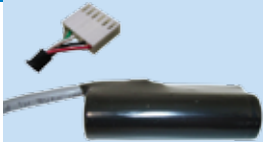

**3M**

**Surgical Shaver (with Tags)**

Part No: EE120157  
1.2V/1900mAh Ni-Cd  
(Dia.x H): 24 x 44mm  
Weight: 55g

CE



**ABBOTT LABORATORIES / HOSPIRA / ROSS**

**Life Care 4200 P.C.A. Pump (Cyclon)**

Part No: EE400130  
8.0V/2500mAh VRLA - AGM  
138 x 34.5 x 68mm  
Weight: 720g

CE



**ABBOTT LABORATORIES / HOSPIRA / ROSS**

**Flexi Flo Companion**

Part No: 04207  
4.0V/1000mAh VRLA - Gel  
34.9 x 42.5 x 50.5 / 51.7mm  
Weight: 180g



**ABBOTT LABORATORIES / HOSPIRA / ROSS**

**Life Care 4200 P.C.A. Pump (Dryfit)**

Part No: EE400132  
8.0V/2500mAh VRLA - Gel  
134 x 36.5 x 67mm  
Weight: 790g

CE

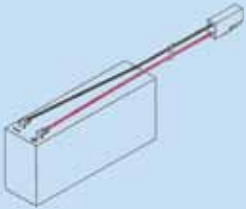

**ABBOTT LABORATORIES / HOSPIRA / ROSS**

**Flexi Flo Patrol**

Part No: 04114  
6.0V/4000mAh VRLA - AGM  
70 x 47 x 102 / 105.5mm  
Weight: 870g



**ABBOTT LABORATORIES / HOSPIRA / ROSS**

**Life Care 5000 / 5500 / 6000**

Part No: 04278  
8.0V/3200mAh VRLA - AGM  
134 x 36 x 66 / 69mm  
Weight: 860g



**ABBOTT LABORATORIES / HOSPIRA / ROSS****Life Care Pump 4 / 5 (Dryfit)**

Part No: 04255  
 8.0V/2700mAh VRLA - Gel  
 133.5 x 36.5 x 63 / 66.6mm  
 Weight: 780g

**AEROSOL PRODUCTS / MG ELECTRIC****SAM 420 Suction Unit**

Part No: EE140217  
 2 x 6.0V/3000mAh Ni-Cd  
 128 x 27 x 103mm  
 Weight: 920g

**ABBOTT LABORATORIES / HOSPIRA / ROSS****Life Care Volumetric Pump 900**

Part No: 04129  
 12.0V/3200mAh VRLA - AGM  
 134 x 67 x 60.5 / 64mm  
 Weight: 1200g

**AIR SHIELDS (also see VICKERS)****Cardiotac Monitor 4000**

Part No: 04207  
 4.0V/1000mAh VRLA - Gel  
 34.9 x 42.5 x 50.5 / 51.7mm  
 Weight: 180g

**ABBOTT LABORATORIES / HOSPIRA / ROSS****TENS Units**

Part No: 01911  
 1.2V/180mAh Ni-Cd  
 (Dia.x H): 12 x 30mm  
 Weight: 8g

**AIR SHIELDS (also see VICKERS)****Transilluminator LT1500**

Part No: EE120232  
 7.2V/1800mAh Ni-Cd  
 72 x 25 x 90mm  
 Weight: 335g

**ABBOTT POINT OF CARE INC.****I-Stat Printer**

Part No: CSA02072  
 4.8V/1600mAh Ni-MH  
 100 x 14.5 x 29mm  
 Weight: 108g

**AIROX****Legendair External Battery (Battery only - no bag or charger)**

Part No: CSD01083  
 24.0V/4200mAh Ni-MH  
 118.5 x 77.5 x 74.5mm  
 Weight: 1250g

**AEROGEN****Aeroneb Nebuliser PRO-X**

Part No: EE300230  
 4.8V/450mAh Ni-MH  
 49 x 35 x 12mm  
 Weight: 60g

**ALCON****Auto Keratometer**

Part No: EE040054  
 6.0V/500mAh Ni-Cd  
 30 x 15.5 x 87.1mm  
 Weight: 73g

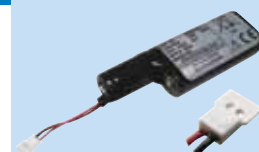
**AEROSOL PRODUCTS / MG ELECTRIC****SAM 90 Suction Controller**

Part No: EE050030  
 12.0V/800mAh Ni-Cd  
 70 x 28 x 15mm  
 Weight: 300g

**AMEDA****Egnell Elite Breast Pump**

Part No: EE050312  
 12.0V/800mAh Ni-Cd  
 73 x 29.8 x 49.2mm  
 Weight: 234g

**AEROSOL PRODUCTS / MG ELECTRIC****SAM 418 Suction Unit**

Part No: EE140147  
 12.0V/2400mAh Ni-Cd  
 132 x 56 x 102mm  
 Weight: 920g

**A&D****Ambulatory BP Monitor TM2421 (send for rebuild)**

Part No: EE050070  
 4.8V/800mAh Ni-Cd  
 58.6 x 15.4 x 49.2mm  
 Weight: 90g





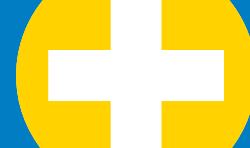



**A&D**  
**TM-2564G / 2564GP Multi Parameter Vital Signs Monitor**  
 Part No: CSA07022  
 9.6V/2000mAh Ni-MH  
 88 x 34 x 34mm  
 Weight: 280g

CE



**ARJO**  
**Maxilift / Trixielift Patient Hoist KTA0102 (send for rebuild)**  
 Part No: CSB14022  
 24.0V/2900mAh VRLA - AGM  
 245 x 90 x 80mm  
 Weight: 2400g



**ARCOMED**  
**Volumed VP2000 and 5000 Vol. Infusion Pump**  
 Part No: EE120122  
 12.0V/1800mAh Ni-Cd  
 120 x 48 x 45mm  
 Weight: 560g

CE



**ARJO**  
**Maxitwin Passive Floor Lift (insert supplied)**  
 Part No: CSB31013  
 24.0V/3000mAh Ni-Cd  
 235 x 24 x 85.8mm  
 Weight: 1140g



**ARCOMED**  
**Volumed VP2000 and 5000 Vol. Infusion Pump**  
 Part No: EE120366  
 12.0V/3000mAh Ni-MH  
 117 x 48 x 45mm  
 Weight: 630g

CE



**ARJO**  
**Maxitwin Passive Floor Lift (send for rebuild)**  
 Part No: CSA31013  
 24.0V/3000mAh Ni-Cd  
 296 x 101 x 48.6mm  
 Weight: 1500g



**ARCOMED**  
**VP5005 Infusion Pump**  
 Part No: EE170313  
 12.0V/5000mAh Ni-Cd  
 125 x 108 x 64mm  
 Weight: 1650g

CE



**ARJO**  
**Patient Lift NDA0100-20 / NDA0100-03 (send for rebuild)**  
 Part No: CSD13070  
 24.0V/4000mAh VRLA - AGM  
 546 x 90 x 65mm  
 Weight: 4035g



**ARCOMED**  
**VP5005 Micro Infusion Pump**  
 Part No: EE090165  
 12.0V/2400mAh Ni-MH  
 85 x 35 x 51mm  
 Weight: 440g

CE



**ARJO**  
**Sara KPA0100 / Opera / Tempo / Encore / Maximove (send for rebuild)**  
 Part No: CSA30060  
 24.0V/5000mAh VRLA - AGM  
 726 x 100 x 72.5mm  
 Weight: 4860g



**ARCOMED**  
**VP6000 / VP7000 / SP6000 Pumps**  
 Part No: EE080044  
 9.6V/2000mAh Ni-MH  
 137 x 18 x 44mm  
 Weight: 285g

CE



**ASPECT MEDICAL SYSTEMS**  
**A2000 Bi-Spectral Monitor**  
 Part No: CSC07129  
 7.2V/2100mAh Ni-MH  
 103 x 44 x 17mm  
 Weight: 230g

CE



**ARJO**  
**Maxilift Hoist**  
 Part No: 02036  
 24.0V/4000mAh VRLA - AGM  
 226 x 100.1 x 123.5mm  
 Weight: 3900g

CE



**ASTROMED**  
**Chart Recorder Dash I / II Mark II Recorder**  
 Part No: 04274  
 12.0V/7200mAh VRLA - AGM  
 151 x 64.5 x 94 / 100mm  
 Weight: 2470g



**ATMOS****Atmolit Suction Pump**

Part No: EE120341  
 12.0V/1900mAh Ni-Cd  
 117 x 25 x 90mm  
 Weight: 560g

**B.BRAUN****Perfusor Basic (4 required per unit)**

Part No: 50023  
 Voltage: 1.5V Primary Alkaline  
 (Dia.x H): 26 x 50mm  
 Weight: 69g

**ATMOS****Atmoport Suction Unit**

Part No: EE140289  
 12.0V/3000mAh Ni-Cd  
 78 x 45 x 104mm  
 Weight: 920g

**B.BRAUN****Perfusor FM Syringe Driver**

Part No: EE120311  
 7.2V/1200mAh Ni-Cd  
 67 x 47 x 44mm  
 Weight: 300g

**ATMOS****Atmoport N Suction Unit (send for rebuild)**

Part No: CSB20023  
 12.0V/3000mAh Ni-Cd  
 206 x 94 x 57mm  
 Weight: 1125g

**B.BRAUN****Perfusor FT (Flat Pack)**

Part No: EE120046  
 7.2V/2000mAh Ni-Cd  
 68 x 23 x 86mm  
 Weight: 310g

**B.BRAUN****Aesculap GA605 Drill (send for rebuild)**

Part No: CSA23052  
 4.8V/1900mAh Ni-Cd  
 98.2 x 49 x 26.5mm  
 Weight: 240g

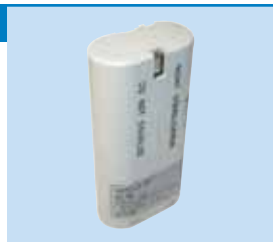
**B.BRAUN****Perfusor FT/P (Triangular pack)**

Part No: EE120093  
 7.2V/1800mAh Ni-Cd  
 48 x 48 x 90mm  
 Weight: 335g

**B.BRAUN****FMS Volumetric Pump**

Part No: EE120367  
 7.2V/1200mAh Ni-Cd  
 67 x 47 x 45mm  
 Weight: 300g

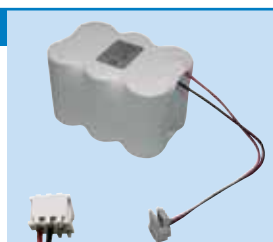
**BARD****2500 Bladder Scan**

Part No: 04021  
 6.0V/5000mAh VRLA - AGM  
 139.2 x 53.8 x 76.7mm  
 Weight: 980g

**B.BRAUN****Infusomat / Dropmat Secura**

Part No: EE170169  
 9.6V/4000mAh Ni-Cd  
 70 x 70 x 120mm  
 Weight: 1250g

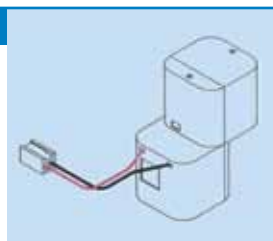
**BARD****2500 Bladder Scan (alternative)**

Part No: 04011  
 6.0V/2500mAh VRLA - AGM  
 113.8 x 46 x 69.9mm  
 Weight: 520g

**B.BRAUN****Infusomat FM Infusion Pump 2000**

Part No: EE140184  
 7.2V/3000mAh Ni-Cd  
 78 x 52 x 52mm  
 Weight: 460g

**BARD****BV105**

Part No: 04021  
 6.0V/5000mAh VRLA - AGM  
 139.2 x 53.8 x 76.7mm  
 Weight: 980g



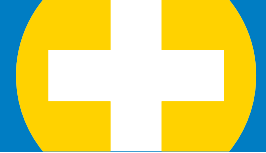

**BARD**  
**Mediwatch PA00141 / PA00145 Bladder Scanner**  
 Part No: EE090279  
 12.0V/3600mAh Ni-MH  
 62 x 50 x 70mm  
 Weight: 600g

CE

**BAXTER**  
**Flo-Guard GPS (send for rebuild)**  
 Part No: CSA23129  
 7.2V/2500mAh Ni-MH  
 107 x 51 x 17mm  
 Weight: 250g

**BAXTER**  
**808 Defibrillator**  
 Part No: 04118  
 6.0V/10Ah VRLA - AGM  
 151 x 50 x 94 / 97.5mm  
 Weight: 1930g

**BAXTER**  
**SMO 200**  
 Part No: 04114  
 6.0V/4000mAh VRLA - AGM  
 70 x 47 x 102 / 105.5mm  
 Weight: 870g

**BAXTER**  
**Colleague Infusion Pump-Memory**  
 Part No: EE460155  
 7.2V/2100mAh Lithium Rechargeable  
 29 x 16.5 x 50mm  
 Weight: 42g

CE

**BCI INTERNATIONAL**  
**3303 Pulse Oximeter**  
 Part No: EE050389  
 9.6V/1000mAh Ni-Cd  
 58.6 x 29.8 x 49.2mm  
 Weight: 240g

CE

**BAXTER**  
**Flo-Guard 100 / 200**  
 Part No: EE050075  
 5 x 1.2V/800mAh Ni-Cd  
 (Dia.x H): 14 x 48.5mm  
 Weight: 112g

CE

**BCI INTERNATIONAL**  
**4402 Pulse Oximeter / Capnocheck 8200**  
 Part No: EE050284  
 9.6V/1200mAh Ni-MH  
 59 x 29 x 49mm  
 Weight: 205g

CE

**BAXTER**  
**Flo-Guard 6000 / 6100 Infusion Pump**  
 Part No: 04118  
 6.0V/10Ah VRLA - AGM  
 151 x 50 x 94 / 97.5mm  
 Weight: 1930g

**BCI INTERNATIONAL**  
**Capnocheck Plus**  
 Part No: EE170444  
 6.0V/5000mAh Ni-Cd  
 165 x 33 x 63mm  
 Weight: 790g

CE

**BAXTER**  
**Flo-Guard 6200 / 6600 Infusion Pump (2 required per unit)**  
 Part No: 04270  
 4.0V/6000mAh VRLA - AGM  
 49.9 x 68.6 x 100.5mm  
 Weight: 880g

**BCI INTERNATIONAL**  
**Capnocheck Plus**  
 Part No: 04231  
 12.0V/2300mAh VRLA - AGM  
 182 x 23 x 61mm  
 Weight: 750g

**BAXTER**  
**Flo-Guard 6300 / 6301 Infusion Pump**  
 Part No: 04233  
 12.0V/3400mAh VRLA - AGM  
 134 x 67 x 60 / 66mm  
 Weight: 1200g

**BLEASE**  
**5500 Osiris 3 (send for rebuild)**  
 Part No: CSA02070  
 9.6V/1600mAh Ni-MH  
 56 x 28 x 50mm  
 Weight: 220g

**BREAS MEDICAL****PV401 Memory**

Part No: EE300020  
 4.8V/80mAh Ni-MH  
 (Dia.x H): 16 x 27mm  
 Weight: 40g

**BREAS MEDICAL****Vivo 50 Ventilator External Battery (send for rebuild)**

Part No: CSB21092  
 2x 18.5V/4800mAh Lithium Rechargeable  
 110 x 75 x 35mm  
 Weight: 465g

**BREAS MEDICAL****PV401 Ventilator**

Part No: 04267  
 12.0V/6500mAh VRLA - Gel  
 151.7 x 65.5 x 94.5 / 98.4mm  
 Weight: 2600g

**BREAS MEDICAL****Vivo 50 Ventilator Internal Battery (send for rebuild)**

Part No: CSA21092  
 37.0V/2400mAh Lithium Rechargeable  
 130 x 75 x 35mm  
 Weight: 465g

**BREAS MEDICAL****PV401 / 2 Internal**

Part No: EE050368  
 24.0V/1300mAh Ni-MH  
 574 x 15.5 x 49mm  
 Weight: 512g

**BURDICK****Atria 6100 EKG (send for rebuild)**

Part No: CSA21099  
 14.4V/2100mAh Ni-MH  
 85 x 28 x 50mm  
 Weight: 375g

**BREAS MEDICAL****PV403 Internal**

Part No: EE090234  
 24.0V/3600mAh Ni-MH  
 661 x 16.5 x 66.5mm  
 Weight: 1210g

**BURDICK****Eclipse 4 / 4iEKG / 400 / 850 / LE11 E.C.G (send for rebuild)**

Part No: EE050443  
 16.8V/800mAh Ni-Cd  
 44.2 x 29.8 x 97.4mm  
 Weight: 327g

**BREAS MEDICAL****SC20 Apnoea Monitor (send for rebuild)**

Part No: CSB29079  
 3.6V/1600mAh Ni-MH  
 51 x 42 x 14mm  
 Weight: 86g

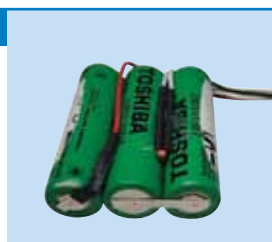
**BURDICK****Eclipse 8 EKG (send for rebuild)**

Part No: CSB26068  
 16.8V/2000mAh Ni-Cd  
 22 x 66 x 210mm  
 Weight: 1050g

**BREAS MEDICAL****Vivo 30/40/50 Ventilator Battery UK**

Part No: CSC05032  
 24.0V/9000mAh Ni-MH  
 300 x 150 x 110mm  
 Weight: 3850g

**BURDICK****Eclipse 8 / Plus EKG (send for rebuild)**

Part No: CSA13118  
 16.8V/2200mAh Ni-Cd  
 180 x 52 x 49mm  
 Weight: 1110g

**BREAS MEDICAL****Vivo 40 Ventilator (send for rebuild)**

Part No: CSA03079  
 16.8V/3800mAh Ni-MH  
 240 x 160 x 30mm  
 Weight: 1015g

**BURDICK****Eclipse Premier Rider EKG (send for rebuild)**

Part No: CSB11111  
 16.8V/5000mAh Ni-Cd  
 450 x 65 x 60mm  
 Weight: 2100g





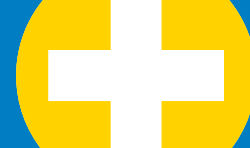

**BURDICK**  
**EK10 / Elite E.C.G / II Machine 862278**

Part No: EE120040  
12.0V/1900mAh Ni-Cd  
115 x 23 x 86mm  
Weight: 500g

CE



**CARDIO RAPID**  
**Portable E.C.G. Machine**

Part No: 04276  
12.0V/800mAh VRLA - AGM  
96 x 25 x 62mm  
Weight: 350g



**CAMBRIDGE INST.**  
**Explorer Mobile X-Ray Unit**

Part No: 04145  
12.0V/24Ah VRLA - AGM  
166 x 175 x 125mm  
Weight: 8800g



**CARDIOLINE**  
**Delta 1 / 3 / 6 Plus**

Part No: EE050319  
24.0V/800mAh Ni-Cd  
80 x 29.8 x 97.4mm  
Weight: 455g

CE



**CAMBRIDGE INST.**  
**SC1000 E.C.G. Machine (send for rebuild)**

Part No: EE050159  
9.6V/800mAh Ni-Cd  
56 x 28 x 50mm  
Weight: 250g



**CARDIOLINE**  
**Delta 60 Plus**

Part No: EE120419  
24.0V/1900mAh Ni-Cd  
88 x 72 x 90mm  
Weight: 1080g

CE



**CAMINO LABORATORIES**  
**Cranial Press Monitor**

Part No: 04131  
12.0V/1200mAh VRLA - AGM  
97 x 48 x 51 / 54.5mm  
Weight: 580g



**CAREFUSION**  
**GW Volumetric Pump 1000EL00349 (send for rebuild)**

Part No: CSA29109  
7.2V/1250mAh Ni-MH  
42 x 28 x 50mm  
Weight: 165g



**CARDIET**  
**AR600 E.C.G**

Part No: EE050395  
9.6V/1600mAh Ni-MH  
65 x 31 x 51mm  
Weight: 300g

CE



**CAREFUSION**  
**Inf. Controller 560 / 565 / 570 / 572 (with connector)**

Part No: 400006  
12.0V/2500mAh VRLA - AGM  
106 x 72 x 69mm  
Weight: 1180g

CE



**CARDIET**  
**AR1200 E.C.G**

Part No: CSA14060  
12.0V/1600mAh Ni-MH  
73 x 30 x 50mm  
Weight: 270g

CE

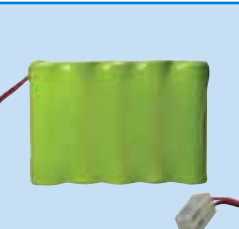

**CAREFUSION**  
**Inf. Controller 560 / 566 (without connector)**

Part No: EE400004  
12.0V/2500mAh VRLA - AGM  
106 x 72 x 69mm  
Weight: 1250g

CE



**CARDIET**  
**Model 100**

Part No: 04276  
12.0V/800mAh VRLA - AGM  
96 x 25 x 62mm  
Weight: 350g



**CAREFUSION**  
**Keo Feed 500 Infusion Pump**

Part No: 04132  
12.0V/2100mAh VRLA - AGM  
178 x 34 x 60.5 / 64mm  
Weight: 960g



### CAREFUSION

#### Keo Feed 3000 Infusion Pump

Part No: 04132  
12.0V/2100mAh VRLA - AGM  
178 x 34 x 60.5 / 64mm  
Weight: 960g



### CAREFUSION

#### ML 3500 / MLA5009 / MK5 SER 15000+ (3.6V Tap)

Part No: EE070089  
3.6V/7.2V/600mAh Ni-Cd  
100 x 17.5 x 28.8mm  
Weight: 120g



### CAREFUSION

#### MK4 / MLA4303 Spirometer

Part No: CSA09031  
7.2V/600mAh Ni-Cd  
102 x 17.5 x 31mm  
Weight: 120g

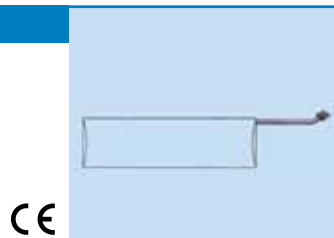

### CAREFUSION

#### MLA2000 / ML 3300 / MK2 SER 2000+

Part No: EE070076  
7.2V/600mAh Ni-Cd  
100 x 17.5 x 28.8mm  
Weight: 120g

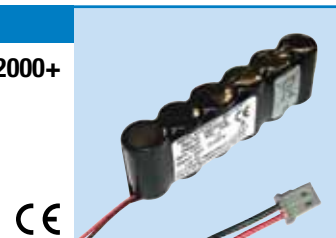

### CAREFUSION

#### Microlab 3000 Spirometer

Part No: EE050196  
4.8V/800mAh Ni-Cd  
29.8 x 15.4 x 97.4mm  
Weight: 94g



### CAREFUSION

#### P Series Memory

Part No: EE300199  
2.4V/80mAh Ni-MH  
(Dia.x H): 16 x 12mm  
Weight: 10g



### CAREFUSION

#### Microlab 3500 MK8 Ser. No. 50000+

Part No: CSC24119  
8.4V/1000mAh Ni-MH  
100 x 45 x 17mm  
Weight: 152g



### CAREFUSION

#### Pump P6000

Part No: 04112  
6.0V/2800mAh VRLA - AGM  
134 x 34 x 60.5 / 64mm  
Weight: 570g



### CAREFUSION

#### Microloop ML3535 Spirometer

Part No: CSA10030  
3.6V/600mAh Ni-Cd  
50 x 30 x 18mm  
Weight: 60g



### CAREFUSION

#### Star Flow Pump 580 / 590 / 599 Series

Part No: 400070  
6.0V/3400mAh VRLA - AGM  
160 x 36 x 68mm  
Weight: 620g



### CAREFUSION

#### ML 3300 / MK3 SER 4000+

Part No: EE070052  
7.2V/600mAh Ni-Cd  
100 x 17.5 x 28.8mm  
Weight: 120g



### CAREFUSION

#### Syringe Pump 770

Part No: EE400065  
6.0V/2500mAh VRLA - AGM  
103 x 34.5 x 68mm  
Weight: 550g



### CAREFUSION

#### ML 3300 / MK 3500 / MK4 SER 9000+ / MLA4303

Part No: EE070067  
7.2V/600mAh Ni-Cd  
100 x 17.5 x 28.8mm  
Weight: 120g



### CAREFUSION

#### Syringe Driver 701 / 711

Part No: EE400042  
8.0V/2500mAh VRLA - AGM  
138 x 34.5 x 68mm  
Weight: 720g



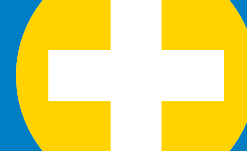

**CAREFUSION**  
**Syringe Driver 741**  
Part No: 04111  
6.0V/1200mAh VRLA - AGM  
97 x 25 x 51 / 54.5mm  
Weight: 310g



**CONMED / LINVATEC / HALL**  
**Sternum Saw 5059-05-BBD50134 (send for rebuild)**  
Part No: CSE09090  
9.6V/1600mAh Ni-Cd  
89 x 64 x 113mm  
Weight: 600g



**CAREFUSION**  
**Syringe Pump P1000 / 7000 Series**  
Part No: 04212  
6.0V/3400mAh VRLA - AGM  
134 x 34 x 60 / 66mm  
Weight: 620g



**COROMETRICS MEDICAL SYSTEMS**  
**Monitor 511**  
Part No: 04273  
6.0V/7200mAh VRLA - AGM  
151 x 34 x 94 / 100mm  
Weight: 1230g



**CAS MEDICAL SYSTEMS INC.**  
**CAS740 Vital Signs Monitor (send for rebuild)**  
Part No: CSA07108  
7.2V/3600Ah Ni-MH  
100 x 70 x 18mm  
Weight: 315g



**COROMETRICS MEDICAL SYSTEMS**  
**Monitor 555**  
Part No: 04138  
12.0V/2300mAh VRLA - AGM  
178 x 34 x 60.5 / 64mm  
Weight: 950g



**CLINICAL DYNAMICS CORPORATION**  
**Smart Sat Pulse Ox. Analyser (send for rebuild)**  
Part No: CSA18012  
19.2V/2200mAh Ni-MH  
44 x 44 x 105mm  
Weight: 490g



**COW & GATE**  
**Flocare 500 Enteral Feed Pump**  
Part No: 04111  
6.0V/1200mAh VRLA - AGM  
97 x 25 x 51 / 54.5mm  
Weight: 310g



**CME**  
**100P E.C.G.**  
Part No: 04276  
12.0V/800mAh VRLA - AGM  
96 x 25 x 62mm  
Weight: 350g



**COW & GATE**  
**Flocare 800 Enteral Feed Pump**  
Part No: 04131  
12.0V/1200mAh VRLA - AGM  
97 x 48 x 51 / 54.5mm  
Weight: 580g



**Argus 708 Infusion Pump**  
Part No: CSA11097  
12.0V/1600mAh Ni-MH  
73 x 30 x 50mm  
Weight: 250g



**COVIDIEN**  
**240 Monitor (2 Required Per Unit)**  
Part No: 04111  
6.0V/1200mAh VRLA - AGM  
97 x 25 x 51 / 54.5mm  
Weight: 310g



**COLIN MEDICAL INSTRUMENTS**  
**Pressmate Blood Pressure Monitor 8800 / 8800C / 8800MSP**  
Part No: 04138  
12.0V/2300mAh VRLA - AGM  
178 x 34 x 60.5 / 64mm  
Weight: 950g



**COVIDIEN**  
**BP Monitor N3100**  
Part No: 50402  
3.0V/48mAh Lithium Primary (Dia.x H): 12.5 x 2.5mm  
Weight: 1g



**COVIDIEN****E300 Patient Monitor**

Part No: 04231  
 12.0V/2300mAh VRLA - AGM  
 182 x 23 x 61mm  
 Weight: 750g

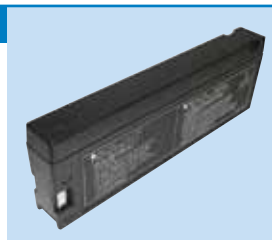
**COVIDIEN****N560 / N550B Mediana Pulse Oximeter**

Part No: EE090298  
 9.6V/3800mAh Ni-MH  
 50.5 x 46 x 69.5mm  
 Weight: 500g

**COVIDIEN****Escort 300 Vital Signs Monitor**

Part No: 04231  
 12.0V/2300mAh VRLA - AGM  
 182 x 23 x 61mm  
 Weight: 750g

**COVIDIEN****N1000 (2 batteries required)**

Part No: 04114  
 6.0V/4000mAh VRLA - AGM  
 70 x 47 x 102 / 105.5mm  
 Weight: 870g

**COVIDIEN****Model N5500 / N5600 (send for rebuild)**

Part No: EE090256  
 14.4V/3600mAh Ni-MH  
 100.5 x 34.9 x 68.5mm  
 Weight: 660g

**COVIDIEN****N3000 / 3100 / 3200 Monitor/ Symphony**

Part No: 02124  
 12.0V/2000mAh VRLA - AGM  
 150 x 20 x 89mm  
 Weight: 700g

**COVIDIEN****N185 Memory**

Part No: 03012  
 3.0V/30mAh Lithium Primary  
 (Dia.x H): 23 x 2.6mm  
 Weight: 2g

**COVIDIEN****N5500P / N5600P Monitor (insert supplied)**

Part No: EE090304  
 12.0V/3800mAh Ni-MH  
 85 x 34 x 68mm  
 Weight: 550g

**COVIDIEN****N200 SLA / N1000 (2 batteries required)**

Part No: 04204  
 6.0V/2900mAh VRLA - AGM  
 66 x 33 x 98 / 103mm  
 Weight: 590g

**COVIDIEN****N6000 Monitor**

Part No: 04233  
 12.0V/3400mAh VRLA - AGM  
 134 x 67 x 60 / 66mm  
 Weight: 1200g

**COVIDIEN****N500-NS (insert supplied)**

Part No: CSA20014  
 8.4V/3800mAh Ni-MH  
 119 x 17 x 68mm  
 Weight: 371g

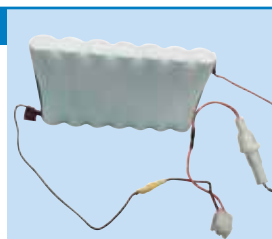
**COVIDIEN****NPB70 / 75 (send for rebuild)**

Part No: EE090208  
 7.2V/2400mAh Ni-MH  
 120 x 34 x 67mm  
 Weight: 285g

**COVIDIEN****N550 Pulse Oximeter**

Part No: 04121  
 12.0V/1200mAh VRLA - AGM  
 97 x 48 x 51 / 54.5mm  
 Weight: 580g

**COVIDIEN****NPB190 / 195 / 290 / 295 / 395 / 595**

Part No: 04114  
 6.0V/4000mAh VRLA - AGM  
 70 x 47 x 102 / 105.5mm  
 Weight: 870g





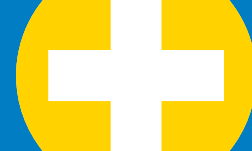



**COVIDIEN**  
**NPB4000 Pulse Oximeter**

Part No: 04031  
 6.0V/8000mAh VRLA - AGM  
 139.2 x 54.1 x 101.6mm  
 Weight: 1430g



**COVIDIEN**  
**Ventilator 7200 Series**

Part No: 04001  
 2.0V/5000mAh VRLA - AGM  
 (Dia.x H): 44.5 x 81.5mm  
 Weight: 362g



**COVIDIEN**  
**Pulse Oximeter N10**

Part No: EE050054  
 6.0V/800mAh Ni-Cd  
 98 x 28 x 72.5mm  
 Weight: 110g

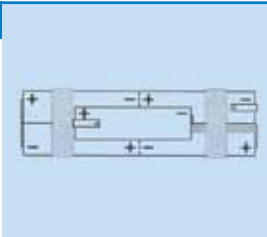

CE

**CRITICARE SYSTEM INC.**  
**500 NIBP Pulse Oximeter**

Part No: 04272  
 12.0V/1200mAh VRLA - AGM  
 97 x 42 x 52 / 59mm  
 Weight: 600g



**COVIDIEN**  
**Pulse Oximeter N10 Printer**

Part No: 50900  
 3.0V/1200mAh Lithium Primary  
 (Dia.x H): 17 x 33.5mm  
 Weight: 14g



**CRITICARE SYSTEM INC.**  
**503 / 1040 / 5040 Pulse Oximeter**

Part No: 04111  
 6.0V/1200mAh VRLA - AGM  
 97 x 25 x 51 / 54.5mm  
 Weight: 310g



**COVIDIEN**  
**Pulse Oximeter N100**

Part No: EE400007  
 12.0V/2500mAh VRLA - AGM  
 103 x 69 x 68mm  
 Weight: 1100g



CE

**CRITICARE SYSTEM INC.**  
**504 DX Pulse Oximeter**

Part No: 04202  
 6.0V/3800mAh VRLA - AGM  
 66 x 33 x 118 / 126mm  
 Weight: 735g



**COVIDIEN**  
**Pulse Oximeter N180 / N185**

Part No: 04231  
 12.0V/2300mAh VRLA - AGM  
 182 x 23 x 61mm  
 Weight: 750g



**CRITICARE SYSTEM INC.**  
**504 Pony**

Part No: 04111  
 6.0V/1200mAh VRLA - AGM  
 97 x 25 x 51 / 54.5mm  
 Weight: 310g



**COVIDIEN**  
**Pulse Oximeter N200 (Cyclon)**

Part No: EE400008  
 6.0V/2500mAh VRLA - AGM  
 103 x 34.5 x 68mm  
 Weight: 550g



CE

**CRITICARE SYSTEM INC.**  
**507 Patient Monitor**

Part No: 04132  
 12.0V/2100mAh VRLA - AGM  
 178 x 34 x 60.5 / 64mm  
 Weight: 960g



**COVIDIEN**  
**Pulse Oximeter N1000 (2 batteries required)**

Part No: 04114  
 6.0V/4000mAh VRLA - AGM  
 70 x 47 x 102 / 105.5mm  
 Weight: 870g



**CRITICARE SYSTEM INC.**  
**507NJ NIBP Monitor / 602-14**

Part No: EE090170  
 7.2V/2700mAh Ni-MH  
 86 x 17 x 51mm  
 Weight: 264g



CE

**CRITICARE SYSTEM INC.****508 Patient Monitor**

Part No: 04219  
 12.0V/4000mAh VRLA - AGM  
 195 x 47 x 70 / 74mm  
 Weight: 1700g

**DATASCOPE / MINDRAY****Intra Aorta Balloon Pump 90 (2 required per unit)**

Part No: 04145  
 12.0V/24Ah VRLA - AGM  
 166 x 175 x 125mm  
 Weight: 8800g

**CRITICARE SYSTEM INC.****Poet 600 / 601 / 602 / 602-1 / 602-2 / 602-3**

Part No: 04233  
 12.0V/3400mAh VRLA - AGM  
 134 x 67 x 60 / 66mm  
 Weight: 1200g

**DATASCOPE / MINDRAY****Intra Aorta Balloon Pump 90 (2 required per unit)**

Part No: 04146  
 12.0V/38Ah VRLA - AGM  
 197 x 165 x 170mm  
 Weight: 14.2kg

**CRITICARE SYSTEM INC.****Poet TE602 Monitor**

Part No: 04132  
 12.0V/2100mAh VRLA - AGM  
 178 x 34 x 60.5 / 64mm  
 Weight: 960g

**DATASCOPE / MINDRAY****Passport Transport Monitor**

Part No: 04231  
 12.0V/2300mAh VRLA - AGM  
 182 x 23 x 61mm  
 Weight: 750g

**CRITICARE SYSTEM INC.****Pulse Oximeter 502 / 50245 / 504 / 50445 / 504US / 506 / 506DXN**

Part No: 04294  
 6.0V/4500mAh VRLA - AGM  
 70 x 47 x 101 / 105mm  
 Weight: 850g

**DATASCOPE / MINDRAY****Transport Balloon Pump 90L / 90T / 95 / 97 / 97E (2 required per unit)**

Part No: 04162  
 12.0V/17.2Ah VRLA - AGM  
 180 x 76 x 167mm  
 Weight: 6210g

**DAMECA****40099-20**

Part No: EE050429  
 14.4V/800mAh Ni-Cd  
 84 x 28 x 52mm  
 Weight: 280g

**DATEX (also see OHMEDA MED PRODUCTS)****AS3 Light Monitor**

Part No: EE050385  
 13.2V/800mAh Ni-Cd  
 262.8 x 15.4 x 97.4mm  
 Weight: 257g

**DATASCOPE / MINDRAY****Accustat Pulse Oximeter**

Part No: 04132  
 12.0V/2100mAh VRLA - AGM  
 178 x 34 x 60.5 / 64mm  
 Weight: 960g

**DATEX (also see OHMEDA MED PRODUCTS)****AS3 Power Supply**

Part No: 04111  
 6.0V/1200mAh VRLA - AGM  
 97 x 25 x 51 / 54.5mm  
 Weight: 310g

**DATASCOPE / MINDRAY****Accutor 3 / 4 NIBP Monitor / 3SAT / 4SAT BP**

Part No: EE400072  
 12.0V/2300mAh VRLA - AGM  
 178 x 34 x 64mm  
 Weight: 960g

**DATEX (also see OHMEDA MED PRODUCTS)****AS3 / AS5 Light Monitor (send for rebuild)**

Part No: EE120444  
 13.2V/2000mAh Ni-Cd  
 47 x 24 x 250mm  
 Weight: 625g



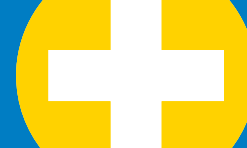

**DATEX** (also see OHMEDA MED PRODUCTS)  
**AS3 / AS5 / LM / LM-1 / LM-P1 Compact Monitor**  
 Part No: EE090107  
 24.0V/1800mAh Ni-Cd  
 85 x 17.5 x 270mm  
 Weight: 940g

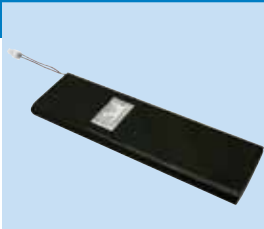

CE

**DATEX** (also see OHMEDA MED PRODUCTS)  
**S5 Compact Anaesthesia (2 required per unit)**  
 Part No: EE090178  
 12.0V/3800mAh Ni-MH  
 133.3 x 84.6 x 17mm  
 Weight: 605g



CE

**DATEX** (also see OHMEDA MED PRODUCTS)  
**AS3 / AS5 / LM / LM-1 / LM-P1 Light Monitor (insert supplied)**  
 Part No: EE120319  
 13.2V/1900mAh Ni-Cd  
 232 x 44 x 22mm  
 Weight: 600g



CE

**DATEX** (also see OHMEDA MED PRODUCTS)  
**Satlite Pulse Oximeter (2 required per unit)**  
 Part No: 04113  
 6.0V/3000mAh VRLA - AGM  
 134 x 34 x 60 / 67mm  
 Weight: 715g



**DATEX** (also see OHMEDA MED PRODUCTS)  
**Cardiocap 5 Monitor**  
 Part No: 04293  
 12.0V/2600mAh VRLA - AGM  
 178 x 34 x 60 / 66mm  
 Weight: 1000g



**DATREND SYSTEM**  
**Infutest Solo Infusion Device**  
 Part No: CSA04012  
 12.0V/1400mAh Ni-Cd  
 84 x 34 x 49mm  
 Weight: 360g



CE

**DATEX** (also see OHMEDA MED PRODUCTS)  
**Flexivent II**  
 Part No: 04216  
 12.0V/2900mAh VRLA - AGM  
 178 x 35 x 60 / 66mm  
 Weight: 1180g



**DATREND SYSTEM**  
**Oxitest 2000**  
 Part No: EE090135  
 7.2V/1400mAh Ni-Cd  
 52 x 35 x 52mm  
 Weight: 211g



CE

**DATEX** (also see OHMEDA MED PRODUCTS)  
**Normacap 200 C02 Monitor**  
 Part No: 04113  
 6.0V/3000mAh VRLA - AGM  
 134 x 34 x 60 / 67mm  
 Weight: 715g



**DELFI MEDICAL INNOVATIONS INC.**  
**7-2200-007 Portable Tourniquet System 9-2200 Series (send for rebuild)**  
 Part No: CSB10123  
 12.0V/2200mAh Ni-MH  
 70 x 28 x 50mm  
 Weight: 320g

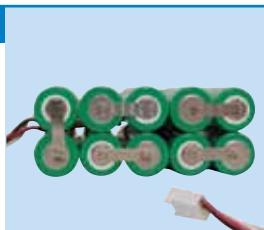

**DATEX** (also see OHMEDA MED PRODUCTS)  
**OSP200**  
 Part No: 04212  
 6.0V/3400mAh VRLA - AGM  
 134 x 34 x 60 / 66mm  
 Weight: 620g



**DELFI MEDICAL INNOVATIONS INC.**  
**Tourniquet 4-2100-017**  
 Part No: CSB23016  
 4.8V/1800mAh Ni-MH  
 50 x 15 x 50mm  
 Weight: 104g



**DATEX** (also see OHMEDA MED PRODUCTS)  
**P200 Pulse Oximeter**  
 Part No: 04233  
 12.0V/3400mAh VRLA - AGM  
 134 x 67 x 60 / 66mm  
 Weight: 1200g



**DELPHI MEDICAL SYSTEMS**  
**Ivantage Pump Internal Battery (send for rebuild)**  
 Part No: CSA29053  
 7.2V/1350mAh Ni-MH  
 50 x 12.5 x 72mm  
 Weight: 150g



**DENTSPLY INTERNATIONAL****X-Smart Pro-Taper**

Part No: CSA03020  
 12.0V/700mAh Ni-MH  
 52 x 45 x 22mm  
 Weight: 135g

**DIAGNOSTIC ULTRASOUND CORP.****Bladder Scan 500 / BVI 2000 / BU12000 / BZI2500**

Part No: 04021  
 6.0V/5000mAh VRLA - AGM  
 139.2 x 53.8 x 76.7mm  
 Weight: 980g

**DEVILBISS HEALTHCARE****Compact Suction**

Part No: 04228  
 12.0V/1300mAh VRLA - AGM  
 97 x 47.5 x 50 / 55mm  
 Weight: 590g

**DIAGNOSTIC ULTRASOUND CORP.****Bladder Scan BV2500**

Part No: 04011  
 6.0V/2500mAh VRLA - AGM  
 113.8 x 46 x 69.9mm  
 Weight: 520g

**DEVILBISS HEALTHCARE****Nebulizer**

Part No: 04129  
 12.0V/3200mAh VRLA - AGM  
 134 x 67 x 60.5 / 64mm  
 Weight: 1200g

**DRAEGER (also see SIEMENS)****8000 Incubator Alarm**

Part No: 03114  
 8.4V/170mAh Ni-MH  
 15.7 x 26.5 x 48.5mm  
 Weight: 32g

**DEVILBISS HEALTHCARE****Pulmo Aid Traveller**

Part No: 04129  
 12.0V/3200mAh VRLA - AGM  
 134 x 67 x 60.5 / 64mm  
 Weight: 1200g

**DRAEGER (also see SIEMENS)****Delta / Gamma Infinity**

Part No: 04265  
 12.0V/2000mAh VRLA - AGM  
 143 x 23 x 64mm  
 Weight: 590g

**DEVILBISS HEALTHCARE****Suction Unit 7305 / Sunrise PU101823**

Part No: EE400159  
 2 x 6.0V/2500mAh VRLA - AGM  
 103 x 69 x 68mm  
 Weight: 1100g

**DRAEGER (also see SIEMENS)****EV800 Ventilator**

Part No: 04249  
 12.0V/2900mAh VRLA - AGM  
 79 x 56 x 99 / 102mm  
 Weight: 1180g

**DEVILBISS HEALTHCARE****Vac-u-Aid / 7304-A / 7304-D**

Part No: 04228  
 12.0V/1300mAh VRLA - AGM  
 97 x 47.5 x 50 / 55mm  
 Weight: 590g

**DRAEGER (also see SIEMENS)****Evita 4 Ventilator (External)**

Part No: 04235  
 12.0V/17Ah VRLA - AGM  
 181 x 76 x 167 mm  
 Weight: 6500g

**DEWERT****Bed Battery**

Part No: CSA13062  
 24.0V/800mAh Ni-Cd  
 69.5 x 69.5 x 50mm  
 Weight: 520g

**DRAEGER (also see SIEMENS)****Evita 4 Ventilator (Internal) XL / 2**

Please enquire further about this product



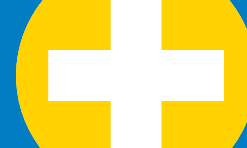

**DRAEGER** (also see SIEMENS)  
**Evita 4 Ventilator Memory**

Part No: 50802  
3.0V/1400mAh Lithium Primary  
(Dia.x H): 12 x 60.4mm  
Weight: 13g



**ELMED**  
**PSO 100 Pulse Oximeter**

Part No: 04200  
12.0V/2200mAh VRLA - AGM  
177 x 34 x 60 / 66mm  
Weight: 800g



**DRAEGER** (also see SIEMENS)  
**Fabius GS Anaesthesia Machine**

Part No: 04129  
12.0V/3200mAh VRLA - AGM  
134 x 67 x 60.5 / 64mm  
Weight: 1200g



**EMS PHYSIO LIMITED**  
**Therasonic 355 Ultrasound (send for rebuild)**

Part No: CSC06062  
12.0V/1800mAh Ni-MH  
72.5 x 29 x 49.2mm  
Weight: 270g



**DRAEGER** (also see SIEMENS)  
**Julian Ventilator**

Part No: 50802  
3.0V/1400mAh Lithium Primary  
(Dia.x H): 12 x 60.4mm  
Weight: 13g



**ENGSTROM**  
**Elvira Ventilator**

Part No: EE050155  
9.6V/800mAh Ni-Cd  
43.8 x 29.8 x 97.4mm  
Weight: 190g

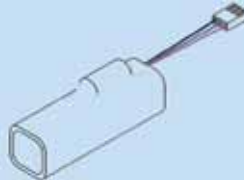

CE

**DRAEGER** (also see SIEMENS)  
**Oxylog 2000**

Part No: EE050305  
7.2V/1000mAh Ni-Cd  
44.2 x 29.8 x 49.2mm  
Weight: 180g



CE

**ESAOTE**  
**Mylab 25**

Part No: 02017  
14.4V/6600mAh Lithium Rechargeable  
167.5 x 107.3 x 21.7mm  
Weight: 652g



**DRAEGER** (also see SIEMENS)  
**Violet Monitor**

Part No: 04212  
6.0V/3400mAh VRLA - AGM  
134 x 34 x 60 / 66mm  
Weight: 620g



**ESCHMANN**  
**Operating Table**

Part No: 04145  
12.0V/24Ah VRLA - AGM  
166 x 175 x 125mm  
Weight: 8800g



**DYNATECH / NEVADA**  
**Impulse 4000 Defibrillator Tester**

Part No: 04132  
12.0V/2100mAh VRLA - AGM  
178 x 34 x 60.5 / 64mm  
Weight: 960g



**FERNO**  
**Streamlight SL20X (Maglite)**

Part No: EE150011  
6.0V/2300mAh Ni-Cd  
(Dia.x H): 33 x 190mm  
Weight: 410g



CE

**EAST RADCLIFFE**  
**RB2 Respirator**

Part No: 04145  
12.0V/24Ah VRLA - AGM  
166 x 175 x 125mm  
Weight: 8800g



**FIBRE OPTIC MEDICAL**  
**ILS-101 Fibre Optic Illuminator**

Part No: EE120372  
7.2V/2000mAh Ni-Cd  
69 x 46 x 45mm  
Weight: 400g

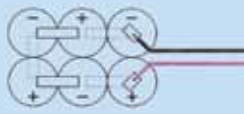

CE

### FLAEM NUOVA

#### Mini Transfer Aspirator

Part No: 04129  
12.0V/3200mAh VRLA - AGM  
134 x 67 x 60.5 / 64mm  
Weight: 1200g



### FUKUDA DENSHI

#### Cardimax FX-2111 / FCP2155 E.C.G. Recorder

Part No: EE050398  
9.6V/1300mAh Ni-MH  
146 x 15.5 x 49mm  
Weight: 256g

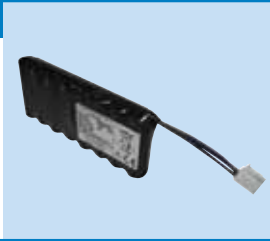

### FLAEM NUOVA

#### T100 (send for rebuild)

Part No: CSA24029  
7.2V/2100mAh Ni-Cd  
75 x 40 x 65mm  
Weight: 350g



### FUKUDA DENSHI

#### T10HRAAC-4781 (send for rebuild)

Part No: CSA27090  
12.0V/1100mAh Ni-MH  
71 x 28.5 x 50mm  
Weight: 280g

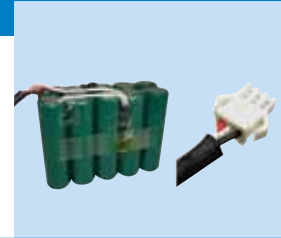

### FRESENIUS

#### 162 Enteil

Part No: 04228  
12.0V/1300mAh VRLA - AGM  
97 x 47.5 x 50 / 55mm  
Weight: 590g



### FUKUDA ME

#### Cardisunny C300 E.C.G

Part No: CSA07103  
9.6V/1900mAh Ni-Cd  
170 x 48 x 22mm  
Weight: 435g



### FRESENIUS

#### Agilia Injectomat Z178130

Part No: 02042  
6.0V/1800mAh Ni-MH  
70.5 x 15 x 50.5mm  
Weight: 160g

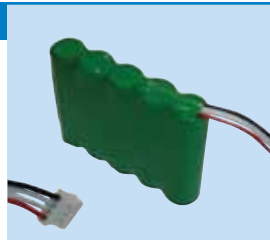

### GE HEALTHCARE

#### 413079-005 (retain backplate)

Part No: EE090224  
13.2V/1400mAh Ni-MH  
193 x 18 x 54mm  
Weight: 387g

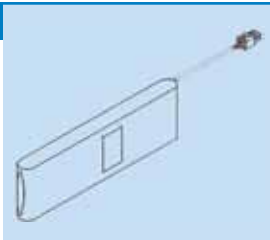

### FRESENIUS

#### Frentamap Feeding Pump

Part No: 04228  
12.0V/1300mAh VRLA - AGM  
97 x 47.5 x 50 / 55mm  
Weight: 590g



### GE HEALTHCARE

#### Cardioserv SCP900 / 910 / 913 / 915 / 922 Defibrillator

Part No: EE120189  
12.0V/1900mAh Ni-Cd  
112 x 28 x 86mm  
Weight: 590g



### FRESENIUS

#### Pilot Z174025

Please enquire further about this product

### GE HEALTHCARE

#### Cardiosmart Mac 500 / 1100 / 1200 / 1200ST E.C.G. Recorder

Part No: EE120345  
18.0V/2000mAh Ni-Cd  
215 x 68 x 22.3mm  
Weight: 840g



### FUKUDA DENSHI

#### 5100

Part No: EE090103  
12.0V/4000mAh Ni-MH  
85 x 35 x 70mm  
Weight: 550g



### GE HEALTHCARE

#### Dash 2500 Patient Monitor (send for rebuild)

Part No: CSA24119  
8.4V/8000mAh Ni-MH  
118 x 34 x 68mm  
Weight: 780g



# REPLACEMENT MEDICAL BATTERIES

FLAEM NUOVA - GE HEALTHCARE (CRITIKON / JOHNSON & JOHNSON)

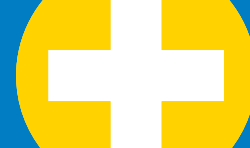

**GE HEALTHCARE**  
**Dash Monitor 3000 / 4000**  
 Part No: 02050  
 11.1V/4200mAh Lithium Rechargeable  
 214 x 18.9 x 52.3mm  
 Weight: 350g



**GE HEALTHCARE**  
**MAC 15 Recorder**  
 Part No: EE070041  
 3.6V/600mAh Ni-Cd  
 51 x 17 x 28mm  
 Weight: 60g



CE

**GE HEALTHCARE**  
**Eagle 1000 Monitor**  
 Part No: EE140294  
 12.0V/2500mAh Ni-Cd  
 130 x 52 x 52mm  
 Weight: 770g



CE

**GE HEALTHCARE**  
**MAC VU E.C.G. Monitor (2 required per unit)**  
 Part No: EE400192  
 12.0V/13Ah VRLA - AGM  
 175 x 84 x 129mm  
 Weight: 5400g

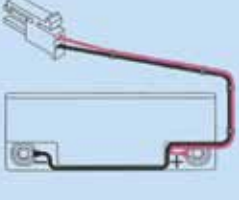

CE

**GE HEALTHCARE**  
**Eagle Monitor High Capacity**  
 Part No: EE140099  
 12.0V/2800mAh Ni-Cd  
 256 x 26 x 51mm  
 Weight: 930g



CE

**GE HEALTHCARE**  
**Tram 7000 Portable Monitor**  
 Part No: 04201  
 12.0V/2000mAh VRLA - AGM  
 201 x 25 x 61mm  
 Weight: 724g



**GE HEALTHCARE**  
**Eagle Monitor Memory**  
 Part No: 50323  
 3.0V/950mAh Lithium Primary  
 (Dia.x H): 24 x 7.7mm  
 Weight: 11g



**GE HEALTHCARE (CRITIKON / JOHNSON & JOHNSON)**  
**2100 Volumetric Infusion Pump**  
 Part No: 04118  
 6.0V/10Ah VRLA - AGM  
 151 x 50 x 94 / 97.5mm  
 Weight: 1930g



**GE HEALTHCARE**  
**Eagle Monitor Standard Capacity**  
 Part No: EE140131  
 12.0V/2500mAh Ni-Cd  
 256 x 26 x 51mm  
 Weight: 930g



CE

**GE HEALTHCARE (CRITIKON / JOHNSON & JOHNSON)**  
**Compact BP T.S. Monitor**  
 Part No: 04231  
 12.0V/2300mAh VRLA - AGM  
 182 x 23 x 61mm  
 Weight: 750g



**GE HEALTHCARE**  
**MAC PC 6 / 12 E.C.G. Recorder (3807-001)**  
 Part No: EE120047  
 19.2V/2000mAh Ni-Cd  
 95 x 24 x 185mm  
 Weight: 890g

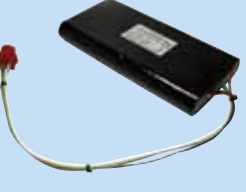

CE

**GE HEALTHCARE (CRITIKON / JOHNSON & JOHNSON)**  
**Dinamap 8100 / 8100T / 8110 / 8120 / 8180XL / 9400 / 9300 / 9340XL / 9350XL / 9500XL Mon.**  
 Part No: 400028  
 12.0V/2800mAh VRLA - AGM  
 132 x 33 x 97 / 104mm  
 Weight: 1120g

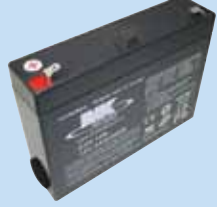

CE

**GE HEALTHCARE**  
**MAC 8 Monitor / Max Personal**  
 Part No: EE170242  
 19.2V/5000mAh Ni-Cd  
 67 x 67 x 239mm  
 Weight: 2600g



CE

**GE HEALTHCARE (CRITIKON / JOHNSON & JOHNSON)**  
**Dinamap Plus 8700 / 8710 / 8720 / 8725 / 9700 / 9710 / 9720 / VSM Plus**  
 Part No: 04231  
 12.0V/2300mAh VRLA - AGM  
 182 x 23 x 61mm  
 Weight: 750g



GE HEALTHCARE (CRITIKON / JOHNSON & JOHNSON)

**Dinamap Pro 100 - 400**

Part No: 04231  
12.0V/2300mAh VRLA - AGM  
182 x 23 x 61mm  
Weight: 750g



GE HEALTHCARE (CRITIKON / JOHNSON & JOHNSON)

**Dinamap Pro 1000 (insert supplied)**

Part No: EE090294  
12.0V/7400mAh Ni-MH  
90 x 72 x 54mm  
Weight: 1200g



GE HEALTHCARE (CRITIKON / JOHNSON & JOHNSON)

**Dinamap ProCare 100 / 300 / 400**

Part No: 04113  
6.0V/3000mAh VRLA - AGM  
134 x 34 x 60 / 67mm  
Weight: 715g



GE HEALTHCARE (CRITIKON / JOHNSON & JOHNSON)

**Oxyshuttle Pulse Oximeter (not fast charge)**

Part No: EE150020  
9.6V/2300mAh Ni-Cd  
66 x 66 x 78mm  
Weight: 660g



GE HEALTHCARE (CRITIKON / JOHNSON & JOHNSON)

**Oxyshuttle Pulse Oximeter II**

Part No: EE170239  
7.2V/5000mAh Ni-Cd  
99 x 66 x 63mm  
Weight: 960g



GE HEALTHCARE (CRITIKON / JOHNSON & JOHNSON)

**Syringe Minder 90**

Part No: 04111  
6.0V/1200mAh VRLA - AGM  
97 x 25 x 51 / 54.5mm  
Weight: 310g



**GOULD**

**SP1405 Physio Monitor**

Part No: 04135  
12.0V/4000mAh VRLA - AGM  
90 x 70 x 102.5 / 106mm  
Weight: 1750g



**GOULD**

**SP1425B Cardiac Output**

Part No: 04110  
6.0V/1000mAh VRLA - AGM  
51 x 42.5 x 51 / 54.5mm  
Weight: 250g



**GOULD**

**SP2004 Blood Flow Monitor**

Part No: 04135  
12.0V/4000mAh VRLA - AGM  
90 x 70 x 102.5 / 106mm  
Weight: 1750g



**GOULD**

**SP2009 Recorder**

Part No: 04137  
12.0V/7000mAh VRLA - AGM  
151 x 65 x 94 / 97.5mm  
Weight: 2790g



**GOULD**

**SP2120 Display Monitor (2 required per unit)**

Part No: 04116  
6.0V/7000mAh VRLA - AGM  
151 x 34 x 94 / 97.5mm  
Weight: 1320g



**GOULD**

**SP2204 Blood Flow Monitor (2 required per unit)**

Part No: 04116  
6.0V/7000mAh VRLA - AGM  
151 x 34 x 94 / 97.5mm  
Weight: 1320g



**GRASEBY**

**3M-500 Volumetric Pump**

Part No: 04228  
12.0V/1300mAh VRLA - AGM  
97 x 47.5 x 50 / 55mm  
Weight: 590g



**GRASEBY**

**3M-AVI200**

Part No: 04132  
12.0V/2100mAh VRLA - AGM  
178 x 34 x 60.5 / 64mm  
Weight: 960g





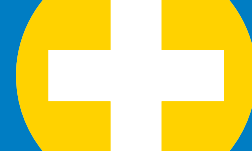

**GRASEBY**  
**304 E.C.G. Monitor**  
 Part No: 02124  
 12.0V/2000mAh VRLA - AGM  
 150 x 20 x 89mm  
 Weight: 700g



**HEMOCHRON**  
**401 Blood Coag. Monitor**  
 Part No: EE120112  
 7.2V/1800mAh Ni-Cd  
 72 x 48 x 45mm  
 Weight: 325g



CE

**GRASEBY**  
**915**  
 Part No: 04111  
 6.0V/1200mAh VRLA - AGM  
 97 x 25 x 51 / 54.5mm  
 Weight: 310g



**HEMOCHRON**  
**FA 5008**  
 Part No: EE050356  
 7.2V/800mAh Ni-Cd  
 150 x 28 x 14mm  
 Weight: 136g

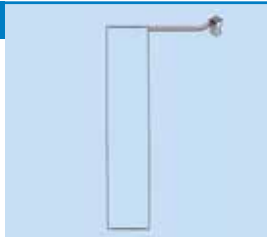

CE

**GRASEBY**  
**2000 Series Syringe Pump**  
 Part No: 04000  
 2.0V/2500mAh VRLA - AGM  
 (Dia.x H): 34.3 x 68.1mm  
 Weight: 178g



**HEMOCHRON**  
**Hemochron Junior Blood Microcoagulation System (send for rebuild)**  
 Part No: CSA17050  
 8.4V/850mAh Ni-Cd  
 175 x 35 x 28mm  
 Weight: 160g



**GRASEBY**  
**3000 Series Syringe Pump (3 required per unit)**  
 Part No: 04000  
 2.0V/2500mAh VRLA - AGM  
 (Dia.x H): 34.3 x 68.1mm  
 Weight: 178g



**HEMOCHRON**  
**Hemochron Signature Plus Blood Microcoagulation System (send for rebuild)**  
 Part No: CSA05110  
 8.4V/1600mAh Ni-MH  
 175 x 35 x 28mm  
 Weight: 160g

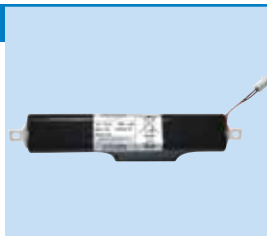

**GRASEBY**  
**9300 AMB PCAS Pump / 903 Oscillomate**  
 Part No: EE090039  
 6.0V/1400mAh Ni-Cd  
 52 x 35 x 51mm  
 Weight: 178g



CE

**HEMOCHRON**  
**Millenium 35000**  
 Part No: 04231  
 12.0V/2300mAh VRLA - AGM  
 182 x 23 x 61mm  
 Weight: 750g



**GRAYSTAD**  
**GSI 17 Audiometer**  
 Part No: EE120324  
 7.2V/1900mAh Ni-Cd  
 70 x 47 x 44mm  
 Weight: 350g

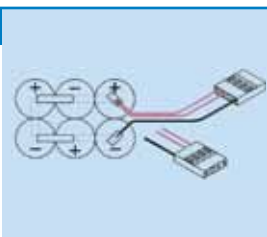

CE

**HEMOCHRON**  
**Response Blood Coagulation System**  
 Part No: EE170460  
 7.2V/5000mAh Ni-Cd  
 99 x 33 x 123mm  
 Weight: 990g



CE

**HAEMOCUE**  
**Haemoglobin Photometer**  
 Part No: EE050165  
 6.0V/800mAh Ni-Cd  
 72 x 14.4 x 50mm  
 Weight: 115g

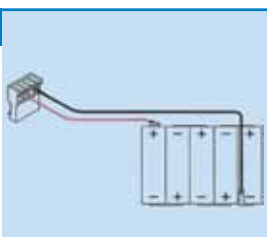

CE

**HEINE**  
**Nica Tron S3Z / S2 Ophthalmoscope**  
 Part No: EE130017  
 3.6V/700mAh Ni-Cd  
 (Dia.x H): 26 x 75mm  
 Weight: 100g



CE

**HEINE****S2Z Ophthalmoscope**

Part No: EE130012  
 2.4V/700mAh Ni-Cd  
 (Dia.x H): 26 x 50mm  
 Weight: 65g

**HELLIGE GMBH****Serviguard SCP900 / 910 / 913 / 915 / 922 Defibrillator**

Part No: EE120189  
 12.0V/1900mAh Ni-Cd  
 112 x 28 x 86mm  
 Weight: 590g

**HELLIGE GMBH****300 Monitor**

Part No: 04231  
 12.0V/2300mAh VRLA - AGM  
 182 x 23 x 61mm  
 Weight: 750g

**HELLIGE GMBH****SMP320 / SMP300 Transport Monitor**

Part No: 04231  
 12.0V/2300mAh VRLA - AGM  
 182 x 23 x 61mm  
 Weight: 750g

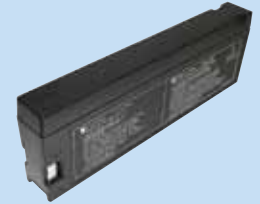
**HELLIGE GMBH****EK51 E.C.G**

Part No: EE050112  
 10.8V/800mAh Ni-Cd  
 44.2 x 15.4 x 145.6mm  
 Weight: 210g

**HEWLETT PACKARD/PHILIPS (also see PHILIPS)****1000E Arrhythmia Monitor**

Part No: 04001  
 2.0V/5000mAh VRLA - AGM  
 (Dia.x H): 44.5 x 81.5mm  
 Weight: 362g

**HELLIGE GMBH****EK53 / EK56 / SMS181 E.K.G**

Part No: EE120100  
 21.6V/1800mAh Ni-Cd  
 72 x 25 x 270mm  
 Weight: 995g

**HEWLETT PACKARD/PHILIPS (also see PHILIPS)****1504 / 1505 E.C.G. Machine**

Part No: 04112  
 6.0V/2800mAh VRLA - AGM  
 134 x 34 x 60.5 / 64mm  
 Weight: 570g

**HELLIGE GMBH****EK41 E.K.G**

Part No: EE120012  
 10.8V/2000mAh Ni-Cd  
 73 x 24 x 135mm  
 Weight: 505g

**HEWLETT PACKARD/PHILIPS (also see PHILIPS)****43100 / 43110 / 43120A / 43130 Monitor/Defibrillator**

Part No: EE400010  
 12.0V/2500mAh VRLA - AGM  
 103 x 34.5 x 140mm  
 Weight: 1100g

**HELLIGE GMBH****SCP852 Defibrillator**

Part No: EE140148  
 12.0V/2500mAh Ni-Cd  
 132 x 27 x 104mm  
 Weight: 770g

**HEWLETT PACKARD/PHILIPS (also see PHILIPS)****78640 / Strip Chart Recorder**

Part No: 04112  
 6.0V/2800mAh VRLA - AGM  
 134 x 34 x 60.5 / 64mm  
 Weight: 570g

**HELLIGE GMBH****SCP912 / SCP840 Defibrillator**

Part No: EE050288  
 18.0V/800mAh Ni-Cd  
 116.2 x 29.8 x 49.2mm  
 Weight: 350g

**HEWLETT PACKARD/PHILIPS (also see PHILIPS)****78660 / 78670 / 78671A Monitor/Defibrillator**

Part No: EE150003  
 12.0V/2300mAh Ni-Cd  
 166 x 67 x 38mm  
 Weight: 825g

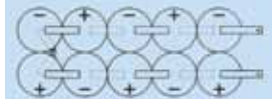

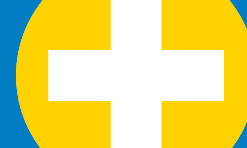

**HEWLETT PACKARD/PHILIPS** (also see PHILIPS)

**A3 Monitor M2929A**

Part No: 04031  
 6.0V/8000mAh VRLA - AGM  
 139.2 x 54.1 x 101.6mm  
 Weight: 1430g



**HEWLETT PACKARD/PHILIPS** (also see PHILIPS)

**M3046A Portable Monitor / Veridia M3/M4 \***

Part No: 02025  
 12.0V/3850mAh Ni-MH  
 148.4 x 88 x 19.1mm  
 Weight: 600g

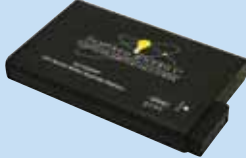

**HEWLETT PACKARD/PHILIPS** (also see PHILIPS)

**Codemaster 100 / 2475B / M2476B (send for rebuild)**

Part No: EE140242  
 12.0V/3000mAh Ni-Cd  
 130 x 52 x 52mm  
 Weight: 920g



**HEWLETT PACKARD/PHILIPS** (also see PHILIPS)

**Merlin M1275A / M1276A Transport Monitor**

Part No: 04231  
 12.0V/2300mAh VRLA - AGM  
 182 x 23 x 61mm  
 Weight: 750g

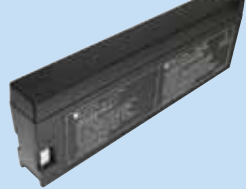

**HEWLETT PACKARD/PHILIPS** (also see PHILIPS)

**Codemaster 100 / M2477B (send for rebuild)**

Part No: EE170342  
 12.0V/4000mAh Ni-Cd  
 165 x 66 x 63mm  
 Weight: 1800g



**HEWLETT PACKARD/PHILIPS** (also see PHILIPS)

**Opti-Go Ultrasound**

Part No: 02082  
 10.8V/7200mAh Lithium Rechargeable  
 214 x 22.2 x 58mm  
 Weight: 500g

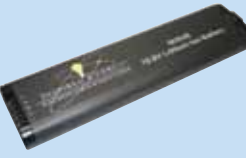

**HEWLETT PACKARD/PHILIPS** (also see PHILIPS)

**Codemaster M1722 / M1723 / M1724 / M1758A / XL / XL Plus Mon./Defib.**

Part No: 400079  
 12.0V/4500mAh VRLA - AGM  
 140 x 48 x 108mm  
 Weight: 1465g

CE



**HEWLETT PACKARD/PHILIPS** (also see PHILIPS)

**Pagewriter 100 & 200 SERIES / 300PI / 1770 / M2460A**

Part No: 400137  
 6.0V/7000mAh VRLA - AGM  
 151 x 34 x 98mm  
 Weight: 1330g

CE



**HEWLETT PACKARD/PHILIPS** (also see PHILIPS)

**M1025 Snoopy Monitor**

Part No: 50902  
 3.0V/5000mAh Lithium Primary  
 (Dia.x H): 26 x 50.5mm  
 Weight: 42g



**HEWLETT PACKARD/PHILIPS** (also see PHILIPS)

**Pagewriter M1700 / 1702 / 1721 E.C.G. Monitor**

Part No: EE400069  
 18.0V/7000mAh VRLA - AGM  
 151 x 102 x 97.5mm  
 Weight: 4000g

CE



**HEWLETT PACKARD/PHILIPS** (also see PHILIPS)

**M1205 Monitor**

Part No: 04231  
 12.0V/2300mAh VRLA - AGM  
 182 x 23 x 61mm  
 Weight: 750g



**HME**

**Lifepulse 400**

Part No: EE090243  
 12.0V/3800mAh Ni-MH  
 170 x 17 x 70mm  
 Weight: 605g

CE



**HEWLETT PACKARD/PHILIPS** (also see PHILIPS)

**M1277A Portable Monitor**

Part No: 04231  
 12.0V/2300mAh VRLA - AGM  
 182 x 23 x 61mm  
 Weight: 750g



**HME**

**Lifepulse Mon LP10 / 15 / LP20**

Part No: EE140108  
 12.0V/2500mAh Ni-Cd  
 131 x 27 x 104mm  
 Weight: 760g

CE



## HORWELL

### Neurothesiometer

Part No: EE050141  
12.0V/800mAh Ni-Cd  
58.6 x 44.2 x 49.2mm  
Weight: 235g



## HUNTLEIGH

### Truman Couch Lift

Part No: 04249  
12.0V/2900mAh VRLA - AGM  
79 x 56 x 99 / 102mm  
Weight: 1180g



## HUNTLEIGH

### Baltimore Bed

Part No: 04111  
6.0V/1200mAh VRLA - AGM  
97 x 25 x 51 / 54.5mm  
Weight: 310g



## IMED

### 800 / 900 Series Infusion Pump

Part No: 04232  
6.0V/12Ah VRLA - AGM  
151 x 50 x 94 / 100mm  
Weight: 2000g



## HUNTLEIGH

### C880 Contura Bed (4 required per unit)

Part No: 04272  
12.0V/1200mAh VRLA - AGM  
97 x 42 x 52 / 59mm  
Weight: 600g



## IMED

### Gemini PC1 Infusion Pump/Controller

Part No: 04273  
6.0V/7200mAh VRLA - AGM  
151 x 34 x 94 / 100mm  
Weight: 1230g



## HUNTLEIGH

### Evolution Bed

Part No: 04131  
12.0V/1200mAh VRLA - AGM  
97 x 48 x 51 / 54.5mm  
Weight: 580g



## IMED

### Gemini PC2 / PC-2TX Infusion Pump / Controller / Model 1320 /1325

Part No: 04232  
6.0V/12Ah VRLA - AGM  
151 x 50 x 94 / 100mm  
Weight: 2000g



## HUNTLEIGH

### Nimbus II Airbed Memory, Auto Excell

Part No: EE300158  
4.8V/40mAh Ni-MH  
(Dia.x H): 12 x 22mm  
Weight: 10g



## IMED

### Gemini PC4 / PC-4-XL (841030)

Part No: 04233  
12.0V/3400mAh VRLA - AGM  
134 x 67 x 60 / 66mm  
Weight: 1200g



## HUNTLEIGH

### Patient Hoist

Part No: 04249  
12.0V/2900mAh VRLA - AGM  
79 x 56 x 99 / 102mm  
Weight: 1180g



## IMED

### Memory Battery PC1 / PC2 / 3800 / 3900 Infusion Pumps

Part No: EE300085  
4.8V/80mAh Ni-MH  
(Dia.x H): 16 x 26mm  
Weight: 40g



## HUNTLEIGH

### Smartsign Patient Monitor SL600NS (send for rebuild)

Part No: CSA12023  
8.4V/7600mAh Ni-MH  
85 x 40 x 70mm  
Weight: 742g



## IMEX MEDICAL SYSTEMS

### Doppler BT0022 / 0024

Part No: EE300143  
12.0V/300mAh Ni-MH  
51 x 25 x 39mm  
Weight: 120g





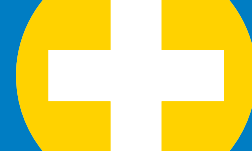

**IMPACT MEDICAL**

**306 Suction pump  
(2 required per unit)**  
Part No: 04116  
6.0V/7000mAh VRLA - AGM  
151 x 34 x 94 / 97.5mm  
Weight: 1320g



**IN-VIVO RESEARCH INC.**

**3155A Patient Monitor**  
Part No: 04231  
12.0V/2300mAh VRLA - AGM  
182 x 23 x 61mm  
Weight: 750g



**INFRASONICS**

**Adult Star 1010 / 1500 Ventilator**  
Part No: 04274  
12.0V/7200mAh VRLA - AGM  
151 x 64.5 x 94 / 100mm  
Weight: 2470g



**IN-VIVO RESEARCH INC.**

**4500 Pulse Oximeter**  
Part No: 04013  
8.0V/2500mAh VRLA - AGM  
79.5 x 92 x 69.9mm  
Weight: 730g



**INNOMED**

**Heartscreen E.C.G  
(send for rebuild)**  
Part No: CSA01110  
8.4V/3000mAh Ni-Cd  
107 x 52 x 75mm  
Weight: 585g



**IN-VIVO RESEARCH INC.**

**4500 / 4501 Pulse Oximeter  
(alternative) 4500 Plus / 5600 / HB07**  
Part No: 04138  
12.0V/2300mAh VRLA - AGM  
178 x 34 x 60.5 / 64mm  
Weight: 950g



**INNOMED**

**Heartscreen HS80G-L E.C.G**  
Part No: CSA06091  
9.6V/1650mAh Ni-MH  
205 x 19 x 14.5mm  
Weight: 245g



CE

**IN-VIVO RESEARCH INC.**

**Omega 500 / 1000 / 1100 / 1500 /  
5000 B.P.M.**  
Part No: 04274  
12.0V/7200mAh VRLA - AGM  
151 x 64.5 x 94 / 100mm  
Weight: 2470g



**INVACARE**

**Freeway Freedom Nebuliser  
(insert supplied / send for rebuild)**  
Part No: CSA12091  
2 x 6.0V/1600mAh Ni-MH  
79 x 26 x 53mm  
Weight: 270g



**IN-VIVO RESEARCH INC.**

**Omega 1400 / 1445 NIBM**  
Part No: 04138  
12.0V/2300mAh VRLA - AGM  
178 x 34 x 60.5 / 64mm  
Weight: 950g



**INVACARE**

**Invacare Freeway Nebuliser**  
Part No: CSG29069  
2 x 6.0V/1600mAh Ni-MH  
98.8 x 43 x 47mm  
Weight: 235g



CE

**IN-VIVO RESEARCH INC.**

**Omega 5600 Pulse Oximeter**  
Part No: 04013  
8.0V/2500mAh VRLA - AGM  
79.5 x 92 x 69.9mm  
Weight: 730g



**INVACARE**

**Opale Patient Hoist**  
Part No: 04249  
12.0V/2900mAh VRLA - AGM  
79 x 56 x 99 / 102mm  
Weight: 1180g



**KCI MEDICAL**

**Freedom V.A.C Pump 320014  
(send for rebuild)**  
Part No: CSB30040  
12.0V/2700mAh Ni-MH  
82 x 50 x 34mm  
Weight: 420g



**KEELER OPTICAL / SITE MICRO SURGICAL****Ophthalmic Headlamp**

Part No: EE120330  
 6.0V/1900mAh Ni-Cd  
 87 x 69 x 23mm  
 Weight: 275g

**KONTRON (ROCHE)****7142 Monitor**

Part No: 04137  
 12.0V/7000mAh VRLA - AGM  
 151 x 65 x 94 / 97.5mm  
 Weight: 2790g

**KEELER OPTICAL / SITE MICRO SURGICAL****Ophthalmoscope 2100**

Part No: EE120149  
 2.4V/1800mAh Ni-Cd  
 (Dia.x H): 25 x 90mm  
 Weight: 120g

**KONTRON (ROCHE)****7143 Micro Recorder**

Part No: 04138  
 12.0V/2300mAh VRLA - AGM  
 178 x 34 x 60.5 / 64mm  
 Weight: 950g

**KEELER OPTICAL / SITE MICRO SURGICAL****Ophthalmoscope Pre-Vista (length 77mm)**

Part No: EE130006  
 3.6V/700mAh Ni-Cd  
 (Dia.x H): 26 x 77mm  
 Weight: 100g

**KONTRON (ROCHE)****7341 Micro Recorder**

Part No: 04138  
 12.0V/2300mAh VRLA - AGM  
 178 x 34 x 60.5 / 64mm  
 Weight: 950g

**KEELER OPTICAL / SITE MICRO SURGICAL****Ophthalmoscope Vista 1919-P-7069 (length 81mm)**

Part No: 100011  
 3.6V/700mAh Ni-Cd  
 (Dia.x H): 26 x 81mm  
 Weight: 100g

**KONTRON (ROCHE)****7501 Defibrillator**

Part No: 04138  
 12.0V/2300mAh VRLA - AGM  
 178 x 34 x 60.5 / 64mm  
 Weight: 950g

**KEELER OPTICAL / SITE MICRO SURGICAL****Porta Power**

Part No: EE120110  
 6.0V/2000mAh Ni-Cd  
 95 x 25 x 70mm  
 Weight: 280g

**KONTRON (ROCHE)****7650**

Part No: 04132  
 12.0V/2100mAh VRLA - AGM  
 178 x 34 x 60.5 / 64mm  
 Weight: 960g

**KEELER OPTICAL / SITE MICRO SURGICAL****SmartPack EP39-22079**

Part No: EE090259  
 7.2V/2500mAh Ni-MH  
 53 x 35 x 53mm  
 Weight: 255g

**KONTRON (ROCHE)****7840 / 7845 Pulse Oximeter**

Part No: 04110  
 6.0V/1000mAh VRLA - AGM  
 51 x 42.5 x 51 / 54.5mm  
 Weight: 250g

**KONTRON (ROCHE)****7141 Monitor**

Part No: 04138  
 12.0V/2300mAh VRLA - AGM  
 178 x 34 x 60.5 / 64mm  
 Weight: 950g

**KONTRON (ROCHE)****Balloon Pump 7000 (2 required per unit)**

Part No: 04145  
 12.0V/24Ah VRLA - AGM  
 166 x 175 x 125mm  
 Weight: 8800g



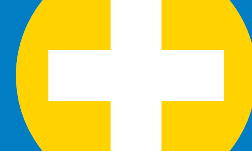



**KONTRON (ROCHE)**  
**Cutaneous CO2 Monitor**  
 Part No: 04118  
 6.0V/10Ah VRLA - AGM  
 151 x 50 x 94 / 97.5mm  
 Weight: 1930g



**LAERDAL**  
**Heart Aid 1000**  
 Part No: 04131  
 12.0V/1200mAh VRLA - AGM  
 97 x 48 x 51 / 54.5mm  
 Weight: 580g



**KONTRON (ROCHE)**  
**E.C.G. Monitor 105 / 108 / 205**  
 Part No: 04137  
 12.0V/7000mAh VRLA - AGM  
 151 x 65 x 94 / 97.5mm  
 Weight: 2790g



**LAERDAL**  
**Heartstart 911 Defibrillator**  
 Part No: 04201  
 12.0V/2000mAh VRLA - AGM  
 201 x 25 x 61mm  
 Weight: 724g



**KONTRON (ROCHE)**  
**Microgas 7141 / 7142 / 7640 Blood Gas Monitor**  
 Part No: 04137  
 12.0V/7000mAh VRLA - AGM  
 151 x 65 x 94 / 97.5mm  
 Weight: 2790g



**LAERDAL**  
**Heartstart 2000 / 3000 / 3000QR Defib./ 901100**  
 Part No: 04201  
 12.0V/2000mAh VRLA - AGM  
 201 x 25 x 61mm  
 Weight: 724g



**KONTRON (ROCHE)**  
**Minimon Monitor**  
 Part No: 04236  
 12.0V/2000mAh VRLA - Gel  
 178.5 x 34.1 x 60.5 / 64.4mm  
 Weight: 1000g



**LAERDAL**  
**Heartstart 4000 Defibrillator**  
 Part No: 04231  
 12.0V/2300mAh VRLA - AGM  
 182 x 23 x 61mm  
 Weight: 750g



**KONTRON (ROCHE)**  
**Trakmon 7220**  
 Part No: 04160  
 12.0V/5000mAh VRLA - AGM  
 90 x 70 x 102 / 106mm  
 Weight: 2010g



**LAERDAL**  
**LSU 780400**  
 Part No: 04231  
 12.0V/2300mAh VRLA - AGM  
 182 x 23 x 61mm  
 Weight: 750g



**KOWA**  
**SL-14 Lamp (send for rebuild)**  
 Part No: CSA09099  
 7.2V/1600mAh Ni-MH  
 135 x 40 x 35mm  
 Weight: 250g



**LAERDAL**  
**Pace Aid 53**  
 Part No: 04228  
 12.0V/1300mAh VRLA - AGM  
 97 x 47.5 x 50 / 55mm  
 Weight: 590g



**LAERDAL**  
**Heart Aid 95 / Heartstart 1000 / 3000 Training Battery**  
 Part No: 04137  
 12.0V/7000mAh VRLA - AGM  
 151 x 65 x 94 / 97.5mm  
 Weight: 2790g



**LAERDAL**  
**Premier Suction Pump**  
 Part No: 04212  
 6.0V/3400mAh VRLA - AGM  
 134 x 34 x 60 / 66mm  
 Weight: 620g



**LAERDAL****Suction Pump**

Part No: 120148  
 2 x 6.0V/2000mAh Ni-Cd  
 58 x 54 x 46mm  
 Weight: 560g

**MANGAR INTERNATIONAL****Air Flow Unit**

Part No: 04138  
 12.0V/2300mAh VRLA - AGM  
 178 x 34 x 60.5 / 64mm  
 Weight: 950g

**LAERDAL****Suction Pump (Compact / Mini)**

Part No: 04131  
 12.0V/1200mAh VRLA - AGM  
 97 x 48 x 51 / 54.5mm  
 Weight: 580g

**MARSDEN****ATOB Weighing Scale**

Part No: CSA13012  
 7.2V/2200mAh Ni-MH  
 43 x 28.5 x 51mm  
 Weight: 190g

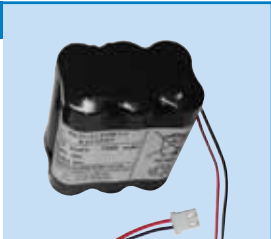
**LIFECARE****Freeway Nebulizer**

Part No: 04113  
 6.0V/3000mAh VRLA - AGM  
 134 x 34 x 60 / 67mm  
 Weight: 715g

**MARSDEN****DP-2400 Weighing Scale**

Part No: CSA23098  
 7.2V/1200mAh Ni-MH  
 43.5 x 29 x 50mm  
 Weight: 170g

**LIKO / HILLROM****Golvo Patient Hoist**

Part No: 04249  
 12.0V/2900mAh VRLA - AGM  
 79 x 56 x 99 / 102mm  
 Weight: 1180g

**MAQUET****1150 Operating Table**

Part No: EE400199  
 12.0V/8000mAh VRLA - AGM  
 300 x 89 x 44mm  
 Weight: 3050g

**LIKO / HILLROM****Viking Hoist (send for rebuild)**

Part No: CSB25051  
 24.0V/2700mAh Ni-MH  
 175 x 30 x 50mm  
 Weight: 800g

**MAQUET****Beta Operating Theatre Table**

Part No: 04248  
 12.0V/10Ah VRLA - Gel  
 152 x 98 x 94.5 / 98.4mm  
 Weight: 4000g

**LIKO / HILLROM****Viking M Portable Hoist**

Part No: CSA07033  
 24.0V/2450mAh Ni-MH  
 176 x 33 x 52mm  
 Weight: 800g

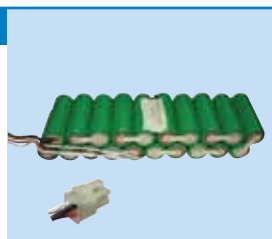
**MAQUET****Operation Table 5090**

Part No: CSA11073  
 24.0V/1900mAh Ni-Cd  
 120 x 48 x 48mm  
 Weight: 600g

**MDE****Escort Monitor**

Part No: 04231  
 12.0V/2300mAh VRLA - AGM  
 182 x 23 x 61mm  
 Weight: 750g

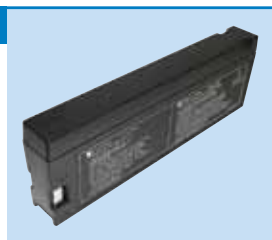
**MAQUET****Transport Systems**

Part No: 04248  
 12.0V/10Ah VRLA - Gel  
 152 x 98 x 94.5 / 98.4mm  
 Weight: 4000g





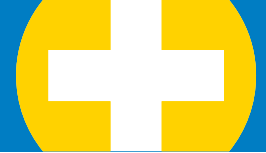

**MASIMO**  
**Radical 7 H/Held Pulse Oximeter 14282 [New Style] (send for rebuild)**  
 Part No: CSA22060  
 4.8V/1650mAh Ni-MH  
 57 x 14.2 x 50mm  
 Weight: 116g



**MEDIWATCH**  
**PortaScan PSA00401 (send for rebuild)**  
 Part No: CSA19101  
 12.0V/4500mAh Ni-MH  
 72 x 50.5 x 67mm  
 Weight: 620g



**MASIMO**  
**Radical 7 Hand Held Pulse Oximeter [Old Style] (insert supplied)**  
 Part No: EE050463  
 4.8V/1600mAh Ni-MH  
 50 x 56 x 14mm  
 Weight: 120g



**MEDIX INFUSION SYSTEMS**  
**Nebulizer Easimist 85301**  
 Part No: EE070043  
 13.2V/600mAh Ni-Cd  
 84 x 33 x 29mm  
 Weight: 210g

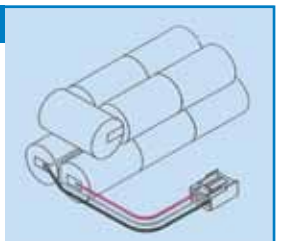

CE

**MEDELA**  
**Clario 600.0806 / 074.0005 Suction Pump**  
 Part No: CSB30049  
 12.0V/2100mAh Ni-MH  
 85 x 34 x 43mm  
 Weight: 330g



CE

**MEDIX INFUSION SYSTEMS**  
**Nebulizer M2057 World Traveller**  
 Part No: EE140156  
 13.2V/1900mAh Ni-Cd  
 180 x 48 x 46mm  
 Weight: 620g



CE

**MEDELA**  
**Vario 919.0012 / 0777.1728 Pump**  
 Part No: EE090305  
 12.0V/2000mAh Ni-MH  
 84 x 35 x 50mm  
 Weight: 370g



**MEDLAB**  
**POX 10 Pulse Oximeter (send for rebuild)**  
 Part No: CSC11023  
 7.2V/1050mAh Ni-Cd  
 42 x 28 x 50mm  
 Weight: 120g



**MEDELA**  
**Vario Suction Pump 077-0137**  
 Part No: 04200  
 12.0V/2200mAh VRLA - AGM  
 177 x 34 x 60 / 66mm  
 Weight: 800g



**MEG**  
**Audiometer FF1 (8.4V tap)**  
 Part No: EE050099  
 16.8V/850mAh Ni-Cd  
 98 x 28 x 49mm  
 Weight: 308g

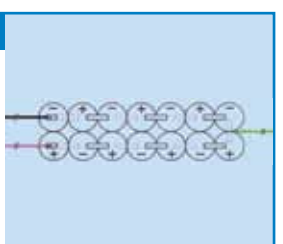

CE

**MEDICAL DIAGNOSTIC EQUIPMENT**  
**Escort Monitor**  
 Part No: 04231  
 12.0V/2300mAh VRLA - AGM  
 182 x 23 x 61mm  
 Weight: 750g



**MINOLTA**  
**Jaundice Meter 101**  
 Part No: EE040003  
 4.8V/270mAh Ni-Cd  
 43 x 15 x 87mm  
 Weight: 145g

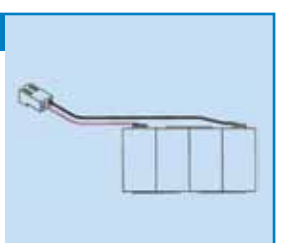

CE

**MEDIWATCH**  
**EzeePzee Portaflow Urological Device (send for rebuild)**  
 Part No: CSA09061  
 9.6V/3800mAh Ni-MH  
 50 x 46 x 67mm  
 Weight: 450g



**MINOLTA**  
**Pulsox 7 Pulse Oximeter / 7820 Mini Ox.**  
 Part No: EE050051  
 7.2V/1200mAh Ni-Cd  
 88 x 15.5 x 66mm  
 Weight: 207g



CE

### MIRAGE HEALTH GROUP LIMITED

#### Propulse III Portable Electronic Ear Irrigator (send for rebuild)

Part No: CSC24081  
6.0V/1500mAh Ni-MH  
77 x 60 x 17mm  
Weight: 150g



### NIHON KOHDEN

#### 8110 Defibrillator / E.C.G.

Part No: 04201  
12.0V/2000mAh VRLA - AGM  
201 x 25 x 61mm  
Weight: 724g

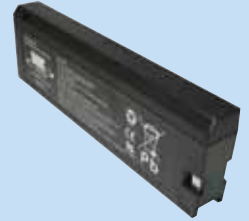

### MOLIFT

#### Hoist (insert supplied)

Part No: EE120380  
14.4V/1500mAh Ni-Cd  
72 x 24 x 180mm  
Weight: 640g



### NIHON KOHDEN

#### Cardiofax 4201 E.C.G.

Part No: 04201  
12.0V/2000mAh VRLA - AGM  
201 x 25 x 61mm  
Weight: 724g



### MOLIFT

#### Quick Raiser (insert supplied / send for rebuild)

Part No: EE120435  
14.4V/1500mAh Ni-Cd  
65 x 34 x 180mm  
Weight: 650g



### NIHON KOHDEN

#### Cardiofax 5101 / 5105 / 5151 E.C.G.

Part No: 04132  
12.0V/2100mAh VRLA - AGM  
178 x 34 x 60.5 / 64mm  
Weight: 960g



### NESBITT & EVANS

#### Patient Hoist

Part No: 04111  
6.0V/1200mAh VRLA - AGM  
97 x 25 x 51 / 54.5mm  
Weight: 310g



### NIHON KOHDEN

#### Cardiofax 6000 Series E.C.G.

Part No: 04201  
12.0V/2000mAh VRLA - AGM  
201 x 25 x 61mm  
Weight: 724g



### NESBITT & EVANS

#### Patient Hoist

Part No: 04249  
12.0V/2900mAh VRLA - AGM  
79 x 56 x 99 / 102mm  
Weight: 1180g



### NIHON KOHDEN

#### Cardiofax 6851K Single Channel E.C.G.

Part No: EE050275  
12.0V/800mAh Ni-Cd  
73 x 29.8 x 49.2mm  
Weight: 230g



### NIHON KOHDEN

#### 1550K E.C.G. (send for rebuild)

Part No: CSB09128  
12.0V/3600mAh Ni-MH  
95.5 x 18.5 x 138.2mm  
Weight: 620g



### NIHON KOHDEN

#### Cardiofax 8420K E.C.G.

Part No: 04231  
12.0V/2300mAh VRLA - AGM  
182 x 23 x 61mm  
Weight: 750g

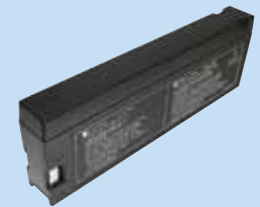

### NIHON KOHDEN

#### 8023G / 9010 / 9020 / 9110 / 9130 / Cardiofax Gem E.C.G.

Part No: 04231  
12.0V/2300mAh VRLA - AGM  
182 x 23 x 61mm  
Weight: 750g

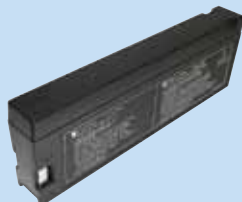

### NIHON KOHDEN

#### Cardiofax 8830K 3 Channel E.C.G.

Part No: 04231  
12.0V/2300mAh VRLA - AGM  
182 x 23 x 61mm  
Weight: 750g

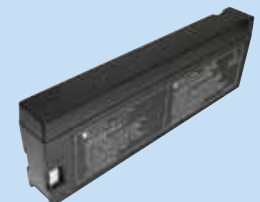

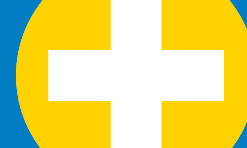

**NIHON KOHDEN**  
**Cardiolife Tec. 7100A / 7200A / 7300A Defib./Monitor**  
 Part No: 04201  
 12.0V/2000mAh VRLA - AGM  
 201 x 25 x 61mm  
 Weight: 724g



**NONIN MEDICAL**  
**8600 / 8604 / 8604D / 8700 / 8800 / 8804 Series Pulse Oximeter / Microspan 1040 / 8604F**  
 Part No: EE120308  
 6.0V/2000mAh Ni-Cd  
 117 x 25 x 45mm Weight: 280g **CE**



**NIHON KOHDEN**  
**Life Scope 6 / 6102A / 6105A / 6543 / 6543A / 6543L / 6551 / 6551A**  
 Part No: 04201  
 12.0V/2000mAh VRLA - AGM  
 201 x 25 x 61mm  
 Weight: 724g



**NONIN MEDICAL**  
**9600 / 2120 Pulse Oximeter**  
 Part No: EE090266  
 7.2V/4000mAh Ni-MH  
 51 x 34 x 71mm  
 Weight: 360g **CE**



**NIHON KOHDEN**  
**Lifescopel I BSM2301K Monitor Battery**  
 Please enquire further about this product

**NOVAMETRIX MEDICAL**  
**505 / 515 / 515A / 520 / 520A / 800 / 840 / 2001 Pulse Oximeter**  
 Part No: 04132  
 12.0V/2100mAh VRLA - AGM  
 178 x 34 x 60.5 / 64mm  
 Weight: 960g



**NIHON KOHDEN**  
**TEC 5531 E.C.G / NKB301V (send for rebuild)**  
 Part No: CSD26088  
 12.0V/3000mAh Ni-MH  
 110 x 46 x 45mm  
 Weight: 605g



**NOVAMETRIX MEDICAL**  
**807 / 811 Trans Oxygen Monitor**  
 Part No: 04111  
 6.0V/1200mAh VRLA - AGM  
 97 x 25 x 51 / 54.5mm  
 Weight: 310g



**NIHON KOHDEN**  
**TEC 8250 E.C.G. / OLV1200K (insert supplied)**  
 Part No: EE120255  
 12.0V/1900mAh Ni-Cd  
 115 x 86 x 23mm  
 Weight: 600g

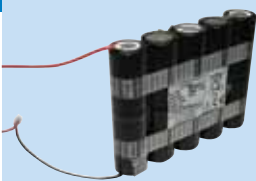

**NOVAMETRIX MEDICAL**  
**903 E.C.G / Apnea Monitor**  
 Part No: 04135  
 12.0V/4000mAh VRLA - AGM  
 90 x 70 x 102.5 / 106mm  
 Weight: 1750g



**NIKKISO**  
**DBB-05 Dialysis System (send for rebuild)**  
 Part No: CSB25102  
 24.0V/1900mAh Ni-MH  
 175 x 34 x 54mm  
 Weight: 775g



**NOVAMETRIX MEDICAL**  
**1200 / 1260 / 7000 CO2 Monitor**  
 Part No: 04135  
 12.0V/4000mAh VRLA - AGM  
 90 x 70 x 102.5 / 106mm  
 Weight: 1750g



**NONIN MEDICAL**  
**7500 Pulse Oximeter 4032-003**  
 Part No: CSB24050  
 7.2V/1800mAh Ni-MH  
 42 x 28 x 51mm  
 Weight: 170g **CE**



**NOVAMETRIX MEDICAL**  
**7100 / 78100 CO2 Monitor**  
 Part No: 04138  
 12.0V/2300mAh VRLA - AGM  
 178 x 34 x 60.5 / 64mm  
 Weight: 950g



### NOVAMETRIX MEDICAL

#### Nova 500

Part No: 04113  
6.0V/3000mAh VRLA - AGM  
134 x 34 x 60 / 67mm  
Weight: 715g



### OHMEDA MEDICAL PRODUCTS (also see DATEX)

#### 3800 / 3900 / 3901 Pulse Oximeter

Part No: 400134  
8.0V/3200mAh VRLA - AGM  
134 x 36 x 68mm  
Weight: 860g

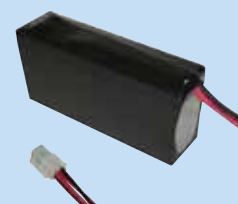

### NOVAMETRIX MEDICAL

#### Transcutaneous Monitor 807 / 811

Part No: 04226  
6.0V/1300mAh VRLA - AGM  
97 x 24 x 50 / 55mm  
Weight: 300g



### OHMEDA MEDICAL PRODUCTS (also see DATEX)

#### Aestiva 5/7100

Part No: EE400216  
6.0V/4200mAh VRLA - AGM  
70 x 48 x 110mm  
Weight: 760g



### NOVAMETRIX MEDICAL

#### Transcutaneous Monitor 840 VFD

Part No: 04138  
12.0V/2300mAh VRLA - AGM  
178 x 34 x 60.5 / 64mm  
Weight: 950g



### OHMEDA MEDICAL PRODUCTS (also see DATEX)

#### Aestiva 5/7900

Part No: EE400145  
12.0V/2200mAh VRLA - AGM  
177 x 34 x 66mm  
Weight: 820g



### NUEROCONTROL CORP.

#### Freehand Controller 99mm x 71mm (send for rebuild)

Part No: CSB03118  
12.0V/800mAh Ni-Cd  
99 x 71 x 15mm  
Weight: 225g



### OHMEDA MEDICAL PRODUCTS (also see DATEX)

#### Biox. IVA / Oximeter

Part No: 04132  
12.0V/2100mAh VRLA - AGM  
178 x 34 x 60.5 / 64mm  
Weight: 960g



### NUEROCONTROL CORP.

#### Freehand Controller 140mm x 51mm (send for rebuild)

Part No: CSC03118  
12.0V/800mAh Ni-Cd  
140 x 51 x 15mm  
Weight: 225g



### OHMEDA MEDICAL PRODUCTS (also see DATEX)

#### Dash Monitor 3000

Part No: 02050  
11.1V/4200mAh Lithium Rechargeable  
214 x 18.9 x 52.3mm  
Weight: 350g



### OHMEDA MEDICAL PRODUCTS (also see DATEX)

#### 3700 Pulse Oximeter

Part No: EE400124  
8.0V/2500mAh VRLA - AGM  
138 x 34.5 x 68mm  
Weight: 720g



### OHMEDA MEDICAL PRODUCTS (also see DATEX)

#### Modulus 2 Plus Ventilator

Part No: 04232  
6.0V/12Ah VRLA - AGM  
151 x 50 x 94 / 100mm  
Weight: 2000g



### OHMEDA MEDICAL PRODUCTS (also see DATEX)

#### Memory Battery PC1 / PC2 / 3800 / 3900 Infusion Pumps

Part No: EE300085  
4.8V/80mAh Ni-MH  
(Dia. x H): 16 x 26mm  
Weight: 40g



### OHMEDA MEDICAL PRODUCTS (also see DATEX)

#### Monitor 5400 / 5410 / 5420 / 6800

Part No: EE120053  
4.8V/1800mAh Ni-Cd  
48 x 25 x 90mm  
Weight: 225g





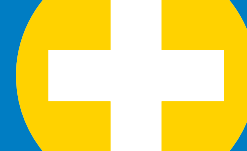

**OHMEDA MEDICAL PRODUCTS** (also see DATEX)

**Pulse Oximeter 3740 / 3760 / 3760P**

Part No: 04200  
12.0V/2200mAh VRLA - AGM  
177 x 34 x 60 / 66mm  
Weight: 800g



**OTODYNAMICS LTD**

**Accucheck Printer MJ09**

Part No: CSA28021  
4.8V/1800mAh Ni-MH  
100 x 28.5 x 14.5mm  
Weight: 109g

CE



**OHMEDA MEDICAL PRODUCTS** (also see DATEX)

**Pulse Oximeter 5000**

Part No: 04137  
12.0V/7000mAh VRLA - AGM  
151 x 65 x 94 / 97.5mm  
Weight: 2790g



**OXYLITRE**

**Petite Elite Suction Pump**

Part No: CSB23112  
12.0V/4300mAh Ni-MH  
92 x 19 x 140mm  
Weight: 600g

CE



**OHMEDA MEDICAL PRODUCTS** (also see DATEX)

**Syringe Pump 9000**

Part No: 04111  
6.0V/1200mAh VRLA - AGM  
97 x 25 x 51 / 54.5mm  
Weight: 310g



**PACETECH**

**NIPD Monitor**

Part No: 04116  
6.0V/7000mAh VRLA - AGM  
151 x 34 x 94 / 97.5mm  
Weight: 1320g



**OHMEDA MEDICAL PRODUCTS** (also see DATEX)

**Trusat 6050-006-578**

Part No: EE120445  
4.8V/3200mAh Ni-MH  
(Dia.x H): 25 x 174mm  
Weight: 245g

CE



**PALCO LABORATORIES**

**300 / 340 Pulse Oximeter**

Part No: EE050326  
7.2V/1200mAh Ni-Cd  
88 x 15.5 x 66mm  
Weight: 207g

CE



**OHMEDA MEDICAL PRODUCTS** (also see DATEX)

**Ventilator Model 7800 / 7810**

Part No: EE120203  
4.8V/2000mAh Ni-Cd  
48 x 25 x 88mm  
Weight: 225g

CE



**PARI MEDICAL**

**Nebulizer**

Part No: EE120393  
12.0V/1900mAh Ni-Cd  
121 x 52 x 48mm  
Weight: 600g

CE

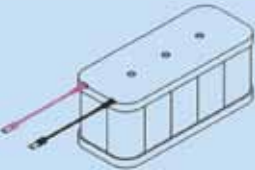

**OMRON HEALTHCARE**

**HEM-907 Blood Pressure Monitor**

Part No: EE050435  
4.8V/1600mAh Ni-MH  
59 x 15.5 x 51mm  
Weight: 120g

CE



**PARI MEDICAL**

**Uni Light Nebuliser (send for rebuild)**

Part No: CSA27101  
12.0V/1600mAh Ni-MH  
115 x 80 x 15mm  
Weight: 285g



**OSCAR BOSCAROL**

**Suction Pump OB2012**

Part No: 04135  
12.0V/4000mAh VRLA - AGM  
90 x 70 x 102.5 / 106mm  
Weight: 1750g



**PARKS ELECTRONICS LABS**

**611 / 809 / 811L / 811S / 911L / 911S / 915L Blood Flow Doppler**

Part No: 04131  
12.0V/1200mAh VRLA - AGM  
97 x 48 x 51 / 54.5mm  
Weight: 580g



**PARKS ELECTRONICS LABS****613 / 614 / 615 / 711 / 801B / 808 / 811 / 812 / 821 / 822 / 912 / 915 Blood Flow Doppler**

Part No: EE300003

12.0V/300mAh Ni-MH

51 x 25 x 39mm

Weight: 120g

**PHILIPS (also see HEWLETT PACKARD)****Atom V2100 Incubator**

Part No: CSA07040

3.6V/80mAh Ni-MH

18.5 x 15.5 x 15.5mm

Weight: 18g

**PARKS ELECTRONICS LABS****925L Blood Flow Doppler**

Part No: 04110

6.0V/1000mAh VRLA - AGM

51 x 42.5 x 51 / 54.5mm

Weight: 250g

**PHILIPS (also see HEWLETT PACKARD)****Bilicheck Analyser (send for rebuild)**

Part No: CSE21062

6.0V/900mAh Ni-Cd

50 x 30 x 60mm

Weight: 120g

**PARKS ELECTRONICS LABS****1010 Blood Flow Doppler**

Part No: 04137

12.0V/7000mAh VRLA - AGM

151 x 65 x 94 / 97.5mm

Weight: 2790g

**PHILIPS (also see HEWLETT PACKARD)****PM9086 / 95 / 97 Scopemeter**

Part No: EE140172

2 x 2.4V/2200mAh Ni-Cd

54 x 26 x 102mm

Weight: 325g

**PEGASUS****Pro Active**

Part No: 04129

12.0V/3200mAh VRLA - AGM

134 x 67 x 60.5 / 64mm

Weight: 1200g

**PHILIPS (also see HEWLETT PACKARD)****Suresigns VS1**

Part No: EE400234

6.0V/5000mAh VRLA - AGM

76 x 88 x 88mm

Weight: 1100g

**PETERS****Peters Audiometer AP26 / 27**

Part No: EE070003

12.0V/600mAh Ni-Cd

34 x 17.5 x 140mm

Weight: 200g

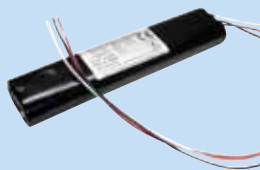
**PHILIPS RESPIRONICS****Remstar Auto A-Flex CPAP Device**

Part No: GSD15103

12.0V/14.4Ah VRLA - AGM

152 x 65 x 205mm

Weight: 4950g

**PHILIPS (also see HEWLETT PACKARD)****A1 Monitor**

Part No: 04282

6.0V/4500mAh VRLA - AGM

70 x 48 x 102 / 108mm

Weight: 720g

**PHYSIO CONTROL****540 / 550 Blood Pump (2 required per unit)**

Part No: 04137

12.0V/7000mAh VRLA - AGM

151 x 65 x 94 / 97.5mm

Weight: 2790g

**PHILIPS (also see HEWLETT PACKARD)****A3 Monitor**

Part No: 04031

6.0V/8000mAh VRLA - AGM

139.2 x 54.1 x 101.6mm

Weight: 1430g

**PHYSIO CONTROL****Cardio Rhythm Atakr**

Part No: 04137

12.0V/7000mAh VRLA - AGM

151 x 65 x 94 / 97.5mm

Weight: 2790g



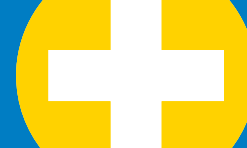

**PHYSIO CONTROL**  
**Lifepak 5 Monitor / Defibrillator / Voice recorder (std/fast charge)**  
 Part No: EE120207  
 12.0V/1000mAh Ni-Cd  
 135.5 x 94 x 28.7mm  
 Weight: 570g

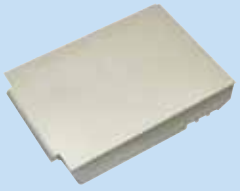

CE

**PHYSIO CONTROL**  
**Lifepak 20 Defibrillator**  
 Part No: EE120417  
 12.0V/3000mAh Ni-MH  
 47 x 24 x 220mm  
 Weight: 620g

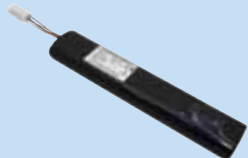

CE

**PHYSIO CONTROL**  
**Lifepak 6 / 6S / 7 Defibrillator**  
 Part No: EE120007  
 12.0V/1900mAh Ni-Cd  
 120 x 25 x 90mm  
 Weight: 550g



CE

**PHYSIO CONTROL**  
**Lifepak 200 Monitor / Defibrillator**  
 Part No: EE400139  
 8.0V/2500mAh VRLA - AGM  
 138 x 34.5 x 68mm  
 Weight: 720g

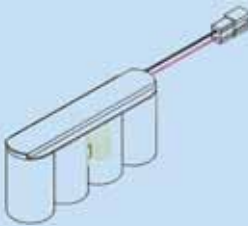

CE

**PHYSIO CONTROL**  
**Lifepak 6 / 7 Monitor / VSM2 E.C.G. Monitor**  
 Part No: EE140011  
 14.4V/2000mAh Ni-Cd  
 128 x 46 x 102mm  
 Weight: 1100g



CE

**PHYSIO CONTROL**  
**Lifestat 100 NIBP Monitor**  
 Part No: EE400017  
 8.0V/2500mAh VRLA - AGM  
 137.2 x 34.3 x 74mm  
 Weight: 712g

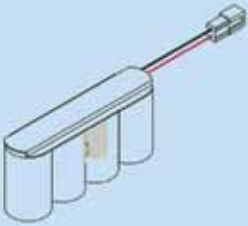

CE

**PHYSIO CONTROL**  
**Lifepak 8 Defibrillator**  
 Part No: EE120256  
 2 x 6.0V/1800mAh Ni-Cd  
 120 x 27 x 48mm  
 Weight: 600g



CE

**PHYSIO CONTROL**  
**Lifestat 1600 Pulse Oximeter**  
 Part No: EE400141  
 8.0V/2500mAh VRLA - AGM  
 69 x 69 x 68mm  
 Weight: 720g



CE

**PHYSIO CONTROL**  
**Lifepak 8 Monitor**  
 Part No: EE150004  
 2 x 9.6V/2300mAh Ni-Cd  
 70 x 64.6 x 32.3mm  
 Weight: 355g

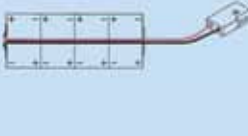

CE

**PHYSIO CONTROL**  
**VSM3 Cardiac Monitor (2 required per unit)**  
 Part No: 04111  
 6.0V/1200mAh VRLA - AGM  
 97 x 25 x 51 / 54.5mm  
 Weight: 310g



**PHYSIO CONTROL**  
**Lifepak 9 Monitor / Defibrillator (Cyclon)**  
 Part No: 400115  
 16.0V/2500mAh VRLA - AGM  
 69 x 69 x 140mm  
 Weight: 1485g



CE

**POSSUM LIMITED**  
**Freeway 1 Nebuliser**  
 Part No: CSC30040  
 6.0V/1050mAh Ni-Cd  
 70 x 50 x 15mm  
 Weight: 105g



CE

**PHYSIO CONTROL**  
**Lifepak 10 & 11 Monitor / Defibrillator (3 required per unit)**  
 Part No: EE120305  
 12.0V/1300mAh Ni-Cd  
 135.5 x 94 x 28.7mm  
 Weight: 570g



CE

**POSSUM LIMITED**  
**Freeway 2 ECU**  
 Part No: EE090287  
 7.2V/3600mAh Ni-MH  
 51 x 17 x 137mm  
 Weight: 360g



CE

**POSSUM LIMITED**

**HC401 Pager**

Part No: CSA12056  
 3.6V/700mAh Ni-MH  
 45 x 32 x 11mm  
 Weight: 45g

CE

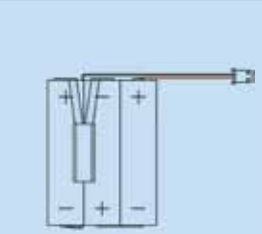

**PROPAQ / PROTOCOL (also see WELCH ALLYN)**

**Propaq Memory**

Part No: 50312  
 3.0V/210mAh Lithium Primary  
 (Dia.x H): 20 x 3.2mm  
 Weight: 3g



**POSSUM LIMITED**

**HC516 User Unit**

Part No: CSD09087  
 2.4V/2300mAh Ni-MH  
 30 x 14.5 x 50mm  
 Weight: 55g

CE



**PULMONETICS**

**LTV 950 / 1000 / 1900 Ventilator**

Part No: EE400171  
 12.0V/4000mAh VRLA - AGM  
 210 x 47 x 70.5mm  
 Weight: 1580g

CE



**POSSUM LIMITED**

**HC517 Junction Box**

Part No: CSC09087  
 12.0V/2200mAh Ni-MH  
 73 x 14.5 x 100mm  
 Weight: 248g

CE



**PURITAN BENNETT**

**Model 840 Ventilator**

Part No: EE400214  
 24.0V/7000mAh VRLA - AGM  
 151 x 132 x 98mm  
 Weight: 5500g

CE



**POSSUM LIMITED**

**HC519 Battery Back Up**

Part No: CSE09087  
 6.0V/700mAh Ni-MH  
 32 x 15.7 x 44mm  
 Weight: 70g

CE



**QUEST MEDICAL (also see TRIMED CORP.)**

**Actester / Coagulation Timer**

Part No: EE090128  
 10.8V/2450mAh Ni-MH  
 52 x 30 x 100mm  
 Weight: 396g

CE



**POSSUM LIMITED**

**HC519B Telecom Back Up Unit (send for rebuild)**

Part No: CSA24101  
 4.8V/1000mAh Ni-MH  
 21.7 x 24 x 45mm  
 Weight: 60g



**QUEST MEDICAL (also see TRIMED CORP.)**

**BCI-AAPLQBC-1108**

Part No: EE050311  
 9.6V/1300mAh Ni-MH  
 58 x 14.5 x 48mm  
 Weight: 300g

CE

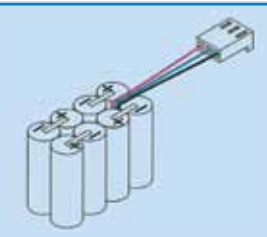

**PROPAQ / PROTOCOL (also see WELCH ALLYN)**

**Propaq 102 / 104 / 106 Monitor without SP02**

Part No: EE400098  
 8.0V/2500mAh VRLA - Gel  
 134 x 36.5 x 67mm  
 Weight: 790g

CE



**RADIOMETER**

**Oxy 1 / 3 / 13 Pulse Oximeter**

Part No: 04111  
 6.0V/1200mAh VRLA - AGM  
 97 x 25 x 51 / 54.5mm  
 Weight: 310g



**PROPAQ / PROTOCOL (also see WELCH ALLYN)**

**Propaq Encore 102 / 104 / 106 / 204 / 206 / 246CS Monitor with SP02**

Part No: EE400105  
 8.0V/5000mAh VRLA - Gel  
 134 x 73 x 67mm  
 Weight: 1570g

CE



**RADIOMETER**

**TCM3 CO2 Cutaneous Monitor (send for rebuild)**

Part No: EE140118  
 7.2V/2000mAh Ni-Cd  
 124 x 75 x 30mm  
 Weight: 450g





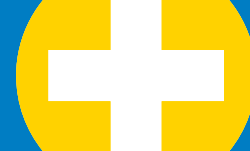

**REFLOLUX**  
**Model 2**  
 Part No: 50061  
 6.0V Primary Alkaline  
 35.6 x 9.2 x 34mm  
 Weight: 34g



**RIGEL MEDICAL**  
**304 / 309 E.C.G. Monitor**  
 Part No: 04112  
 6.0V/2800mAh VRLA - AGM  
 134 x 34 x 60.5 / 64mm  
 Weight: 570g



**REFLOLUX**  
**Model 5**  
 Part No: 50500  
 6.0V/120mAh Primary Alkaline  
 (Dia.x H): 13 x 25.2mm  
 Weight: 12g



**RIGEL MEDICAL**  
**Multicare Monitor 409 Mempac**  
 Part No: 03010  
 3.6V/150mAh Ni-MH  
 15.3 x 26.8 x 18mm  
 Weight: 19g



**REMEDI**  
**ENM Pain Relief Device**  
 Part No: EE300235  
 8.4V/200mAh Ni-MH  
 15 x 26 x 53mm  
 Weight: 60g



CE

**RIGEL MEDICAL**  
**UNI-SiM Vital Signs Simulator**  
 Part No: CSB20091  
 7.2V/2200mAh Ni-MH  
 86 x 14.5 x 50mm  
 Weight: 195g

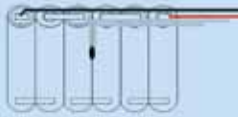

CE

**RESPIRONICS**  
**Criterion 40/60**  
 Part No: EE050401  
 6.0V/1800mAh Ni-MH  
 73.5 x 15.5 x 50.2mm  
 Weight: 150g



CE

**RSL STEEPER**  
**Puma Telephone**  
 Part No: CSA20116  
 6.0V/1600mAh Ni-MH  
 73 x 15 x 50mm  
 Weight: 135g

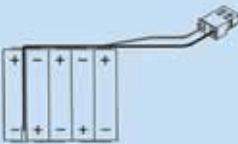

CE

**RESPIRONICS**  
**Harmony Battery Charger - Suitable For 9303 Battery (non-original)**  
 Part No: EE460300  
 Output: 1.8A  
 240 x 160 x 55mm  
 Weight: 600g



CE

**S & W (also see AIR SHIELDS)**  
**C450 Incubator**  
 Part No: EE300160  
 8.4V/300mAh Ni-MH  
 (Dia.x H): 26 x 60mm  
 Weight: 85g



CE

**RESPIRONICS**  
**Harmony Ventilator 9303**  
 Part No: EE180113  
 13.2V/10Ah Ni-Cd  
 268 x 50 x 200mm  
 Weight: 4970g



CE

**S & W (also see AIR SHIELDS)**  
**CardioAid 25 / 50 / 100 / LS / MC / MC+**  
 Part No: EE120124  
 12.0V/1900mAh Ni-Cd  
 120 x 28.3 x 90mm  
 Weight: 560g



CE

**RESPIRONICS**  
**Bipap Focus**  
 Part No: EE090306  
 9.6V/3800mAh Ni-MH  
 77 x 32 x 67mm  
 Weight: 460g



CE

**S & W (also see AIR SHIELDS)**  
**Cardioaid DMS 700 / 730 / 750 Monitor / Defibrillator**  
 Part No: EE150009  
 12.0V/2300mAh Ni-Cd  
 99 x 60 x 76mm  
 Weight: 880g



CE

**S & W** (also see AIR SHIELDS)

**Defi.2 Monitor/Defibrillator**  
(no connector)

Part No: EE120020  
2 x 12.0V/1900mAh Ni-Cd  
96 x 65 x 45mm  
Weight: 2280g



**SECA**

**Bedscales Model 682 / 955 / 985**

Part No: EE050388  
7.2V/1300mAh Ni-MH  
44.5 x 30 x 49mm  
Weight: 154g



**S & W** (also see AIR SHIELDS)

**Diascope Traveller**

Part No: 04231  
12.0V/2300mAh VRLA - AGM  
182 x 23 x 61mm  
Weight: 750g



**SECA**

**Cardiostat 3600**

Part No: EE120358  
12.0V/1900mAh Ni-Cd  
47 x 25 x 220mm  
Weight: 550g



**SCALE-TRONIX INC.**

**Bed Scale 2500**  
(4 required per unit)

Part No: 04111  
6.0V/1200mAh VRLA - AGM  
97 x 25 x 51 / 54.5mm  
Weight: 310g



**SECA**

**CT6Pi E.C.G**

Part No: 04216  
12V/2900mAh VRLA - AGM  
178 x 35 x 60 / 66mm  
Weight: 1180g



**SCHILLER**

**AT-1 E.K.G.**

Part No: 04131  
12.0V/1200mAh VRLA - AGM  
97 x 48 x 51 / 54.5mm  
Weight: 580g



**SECA**

**CT3000**

Part No: 04131  
12.0V/1200mAh VRLA - AGM  
97 x 48 x 51 / 54.5mm  
Weight: 580g



**SCHILLER**

**AT-4 / AT-5 E.K.G.**

Part No: EE050302  
9.6V/1200mAh Ni-MH  
30 x 15.5 x 193mm  
Weight: 205g



**SECA**

**CT61 E.C.G.**

Part No: 04132  
12.0V/2100mAh VRLA - AGM  
178 x 34 x 60.5 / 64mm  
Weight: 960g



**SCHILLER**

**AT-6 / 60 E.K.G.**

Part No: 04132  
12.0V/2100mAh VRLA - AGM  
178 x 34 x 60.5 / 64mm  
Weight: 960g



**SECA**

**Model 644 / 944 / 954 / 958 / 959 / 964 Scales**

Part No: EE050200  
7.2V/800mAh Ni-Cd  
44.2 x 29.8 x 49.2mm  
Weight: 140g



**SCHILLER**

**AT-10 E.K.G.**  
(2 required per unit)

Part No: 04130  
12.0V/800mAh VRLA - AGM  
96 x 25 x 61.5mm  
Weight: 350g



**SECA**

**Model 727 Scales**

Part No: EE050166  
9.6V/800mAh Ni-Cd  
58.6 x 29.8 x 49.2mm  
Weight: 187g



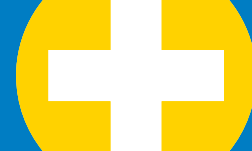

**SECA**

**SC1000 E.C.G. Recorder**  
(send for rebuild)  
Part No: EE050159  
9.6V/800mAh Ni-Cd  
56 x 28 x 50mm  
Weight: 250g



**SIEMENS / BURDICK**

**SC7000 / 9000**

Part No: EE090263  
2 x 6.0V/1400mAh Ni-Cd  
85 x 16.5 x 48.5mm  
Weight: 240g



CE

**SEWARD MEDICAL**

**9911 E.C.G. Monitor**  
(2 required per unit)  
Part No: 04112  
6.0V/2800mAh VRLA - AGM  
134 x 34 x 60.5 / 64mm  
Weight: 570g



**SIEMENS / BURDICK**

**SC7000 / 9000XL Internal**

Part No: 04233  
12.0V/3400mAh VRLA - AGM  
134 x 67 x 60 / 66mm  
Weight: 1200g



**SEWARD MEDICAL**

**AFM6 / AFM210**

Part No: EE050174  
9.6V/800mAh Ni-Cd  
57 x 50 x 28mm  
Weight: 185g

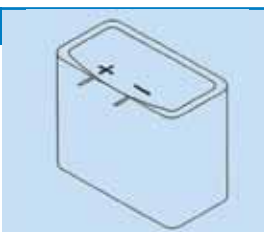

CE

**SIEMENS / BURDICK**

**SC9000XL / SC7000 External**

Part No: 04231  
12.0V/2300mAh VRLA - AGM  
182 x 23 x 61mm  
Weight: 750g



**SHERWOOD MED. / AMERICAN HOSP. SUPPLIES**

**Kangaroo Feed Pumps 224 / 324**

Part No: EE120032  
7.2V/1800mAh Ni-Cd  
120 x 48 x 45mm  
Weight: 360g



CE

**SIEMENS / BURDICK**

**Servo SC300**

Part No: 04138  
12.0V/2300mAh VRLA - AGM  
178 x 34 x 60.5 / 64mm  
Weight: 950g



**SHERWOOD MED. / AMERICAN HOSP. SUPPLIES**

**Kangaroo Feed Pump 2100 (PET)**

Part No: EE120125  
3.6V/2000mAh Ni-Cd  
75 x 25 x 45mm  
Weight: 165g



CE

**SIEMENS / BURDICK**

**Sirecard 440 E.C.G.**

Part No: 04110  
6.0V/1000mAh VRLA - AGM  
51 x 42.5 x 51 / 54.5mm  
Weight: 250g



**SIEMENS / BURDICK**

**Cardiostat 31 / 31S E.C.G.**

Part No: 04200  
12.0V/2200mAh VRLA - AGM  
177 x 34 x 60 / 66mm  
Weight: 800g



**SIEMENS / BURDICK**

**Ventilator 710**

Part No: 04200  
12.0V/2200mAh VRLA - AGM  
177 x 34 x 60 / 66mm  
Weight: 800g



**SIEMENS / BURDICK**

**Medicare**

Part No: 04282  
6.0V/4500mAh VRLA - AGM  
70 x 48 x 102 / 108mm  
Weight: 720g



**SIEMENS / BURDICK**

**CardioAid 25 / 50 / 100 / LS / MC / MC+**

Part No: EE120124  
12.0V/1900mAh Ni-Cd  
120 x 28.3 x 90mm  
Weight: 560g



CE

### SMITHS MEDICAL / MEDEX

#### Medfusion 3010 / 3500 Syringe Pump (Ni-MH) (send for rebuild)

Part No: CSB24119  
7.2V/2100mAh Ni-MH  
100 x 18 x 50mm  
Weight: 250g



### SPACELABS MEDICAL

#### 90305 / 90306 / 90315 / 90316 PC2 Monitor (3 required per unit)

Part No: 04242  
8.0V/3500mAh VRLA - Gel  
178.5 x 34.1 x 60.5 / 64.4mm  
Weight: 1000g



### SONICAID MEDICAL

#### Foetal Heart Monitor D206 / D206F

Part No: EE050011  
9.6V/800mAh Ni-Cd  
56 x 28.9 x 48.2mm  
Weight: 168g

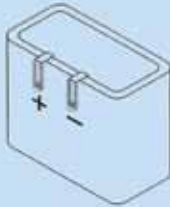

### SPACELABS MEDICAL

#### 90308 P.C. Express Monitor

Part No: 04231  
12.0V/2300mAh VRLA - AGM  
182 x 23 x 61mm  
Weight: 750g

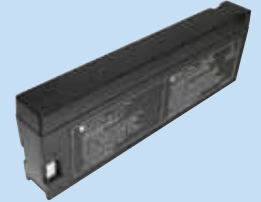

### SPACELABS MEDICAL

#### 1st Medic 510 / 550 / 610 Defibrillator

Part No: 04231  
12.0V/2300mAh VRLA - AGM  
182 x 23 x 61mm  
Weight: 750g

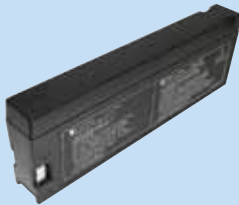

### SPACELABS MEDICAL

#### 90309 P.C. Scout Monitor

Part No: 04231  
12.0V/2300mAh VRLA - AGM  
182 x 23 x 61mm  
Weight: 750g

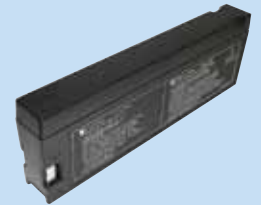

### SPACELABS MEDICAL

#### 1050 / 040-1073-00 / 146-0055-00 / SL90369 / 91369 Monitor

Part No: EE090241  
12.0V/2400mAh Ni-MH  
181 x 61 x 24mm  
Weight: 465g

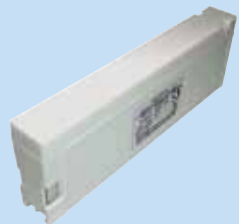

### SPACELABS MEDICAL

#### 90600 Series Clock

Part No: 50800  
3.0V/190mAh Lithium Primary  
(Dia.x H): 11.6 x 10.8mm  
Weight: 3g



### SPACELABS MEDICAL

#### 1050 / 90369 Monitor

Part No: 04231  
12.0V/2300mAh VRLA - AGM  
182 x 23 x 61mm  
Weight: 750g

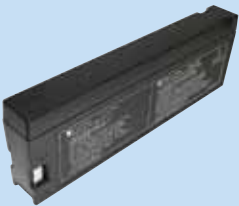

### SPACELABS MEDICAL

#### PCI / PC2 Monitor (2 required per unit)

Part No: 04132  
12.0V/2100mAh VRLA - AGM  
178 x 34 x 60.5 / 64mm  
Weight: 960g



### SPACELABS MEDICAL

#### 90207 Ambulatory Blood Pressure Monitor

Part No: 50800  
3.0V/190mAh Lithium Primary  
(Dia.x H): 11.6 x 10.8mm  
Weight: 3g



### SPACELABS MEDICAL

#### Power Brick

Part No: 04276  
12.0V/800mAh VRLA - AGM  
96 x 25 x 62mm  
Weight: 350g



### SPACELABS MEDICAL

#### 90303 / 90303B / 90311 / 90312 / 90312A / 90315 Memory

Part No: 50800  
3.0V/190mAh Lithium Primary  
(Dia.x H): 11.6 x 10.8mm  
Weight: 3g



### SPACELABS MEDICAL

#### Systems Recorder 2446

Part No: 04132  
12.0V/2100mAh VRLA - AGM  
178 x 34 x 60.5 / 64mm  
Weight: 960g





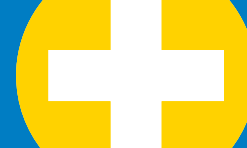

**SPACELABS MEDICAL**  
**Twin Charger (for 1050 Ni-MH Battery)**  
 Part No: 04929  
 12.0V/1A x 2  
 301 x 140 x 97mm  
 Weight: 3295g



**TALLEY GROUP LIMITED**  
**Venturi Compact Wound Therapy Device (send for rebuild)**  
 Part No: CSA01022  
 3.7V/2600mAh Lithium Rechargeable  
 70 x 18 x 18mm  
 Weight: 48g



**SPACELABS MEDICAL**  
**Ultraview 146-0053-00**  
 Part No: EE020033  
 12.0V/700mAh Ni-MH  
 53.5 x 22 x 44.6mm  
 Weight: 145g



CE

**TENSCARE LIMITED**  
**Tenscare Ultima IF4160 Electrode Placement Device**  
 Part No: CSA30079  
 4.8V/1600mAh Ni-MH  
 57 x 14.5 x 51mm  
 Weight: 113g



CE

**STRYKER**  
**T4 Personal Protection System (Insert supplied)**  
 Part No: CSA19121  
 6.0V/3650mAh Ni-MH  
 68 x 51 x 32mm  
 Weight: 280g



**TERUMO**  
**TE171 / TE172 Infusion Pump**  
 Part No: EE120386  
 9.6V/1200mAh Ni-Cd  
 96 x 65 x 45mm  
 Weight: 400g

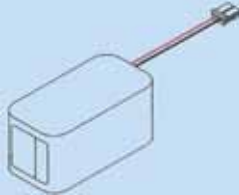

CE

**SUNRISE MEDICAL**  
**Oxford Hoist**  
 Part No: 04120  
 6.0V/1200mAh VRLA - AGM  
 151 x 50 x 93.5 / 97.5mm  
 Weight: 2050g



**TERUMO**  
**TE331/TE332 S Terufusion Syringe Pump**  
 Part No: 02043  
 9.6V/2000mAh Ni-MH  
 58.5 x 29.5 x 50.1mm  
 Weight: 240g

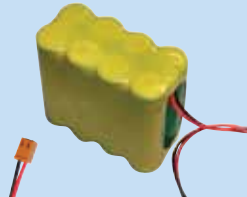

**SUNRISE MEDICAL**  
**Oxford Hoist Model 125**  
 Part No: 04249  
 12.0V/2900mAh VRLA - AGM  
 79 x 56 x 99 / 102mm  
 Weight: 1180g



**THORATEC CORPORATION**  
**CentriMag Blood Pump - Primary Console**  
 Part No: CSB24079  
 20.4V/4500mAh Ni-MH  
 159 x 36 x 67mm  
 Weight: 1030g



CE

**SUNRISE MEDICAL**  
**Oxford Voyager Portable Hoist**  
 Part No: CSA05107  
 24.0V/2300mAh VRLA - AGM  
 182 x 23 x 122.6mm  
 Weight: 1400g



CE

**TOBY CHURCHILL LTD**  
**CPM Elbow Unit SC104**  
 Part No: EE140281  
 7.2V/3000mAh Ni-Cd  
 76.6 x 26.2 x 105mm  
 Weight: 510g

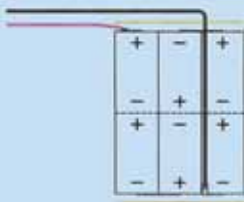

CE

**SUZUKEN KENZ**  
**103 / 106 E.C.G. Recorder**  
 Part No: EE050279  
 21.6V/800mAh Ni-Cd  
 85 x 42.5 x 50mm  
 Weight: 410g

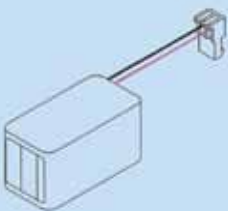

CE

**TOBY CHURCHILL LTD**  
**Lightwriter**  
 Part No: EE090052  
 4.8V/1400mAh Ni-Cd  
 35 x 18 x 101mm  
 Weight: 143g



CE

**TOBY CHURCHILL LTD****Light Writer SL1**

Part No: 03036  
 1.2V/150mAh Ni-MH  
 14.1 x 25.6 x 5.85mm  
 Weight: 7g

**VIASYS HEALTHCARE INC.****Vela Ventilator**

Part No: CSA21031  
 12.0V/4500mAh Ni-MH  
 90 x 36 x 68mm  
 Weight: 620g

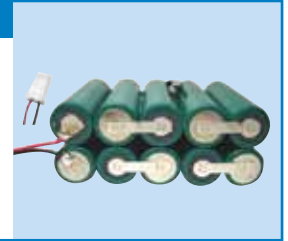
**TOBY CHURCHILL LTD****Light Writer SL4B**

Part No: EE170391  
 4.8V/5000mAh Ni-Cd  
 236 x 34 x 34mm  
 Weight: 620g

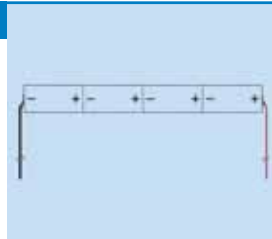
**VICKERS (also see AIR SHIELDS)****77 Transport Incubator**

Part No: 04214  
 12.0V/33mAh VRLA - Gel  
 210 x 175 x 175 / 210mm  
 Weight: 14.6kg

**TOBY CHURCHILL LTD****Light Writer SL30 / 35**

Part No: EE050372  
 4.8V/2200mAh Ni-MH  
 30 x 15.5 x 99.8mm  
 Weight: 103g

**VICKERS (also see AIR SHIELDS)****IP5 Syringe Pump**

Part No: 04132  
 12.0V/2100mAh VRLA - AGM  
 178 x 34 x 60.5 / 64mm  
 Weight: 960g

**TOBY CHURCHILL LTD****Light Writer SL86**

Part No: EE170450  
 4.8V/5000mAh Ni-Cd  
 66 x 33 x 123mm  
 Weight: 640g

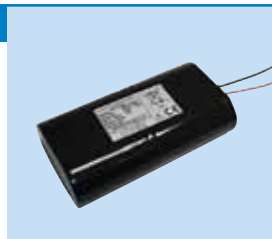
**VICKERS (also see AIR SHIELDS)****Trailblazer Incubator / Ventilator**

Part No: EE090069  
 7.2V/1400mAh Ni-Cd  
 105 x 52 x 52mm  
 Weight: 200g

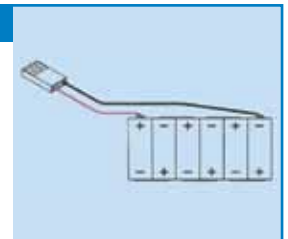
**TOBY CHURCHILL LTD****Light Writer SL87**

Part No: CSB24103  
 4.8V/2700mAh Ni-MH  
 97 x 34 x 17mm  
 Weight: 160g

**VIOMEDIX****Feed Pump X700F**

Part No: 04226  
 6.0V/1300mAh VRLA - AGM  
 97 x 24 x 50 / 55mm  
 Weight: 300g

**TRIMED CORP. (also see QUEST MEDICAL)****Actester / Blood Coagulation Tester PA-1000**

Part No: EE140146  
 10.8V/2000mAh Ni-Cd  
 47 x 42 x 134mm  
 Weight: 500g

**VIOMEDIX****VX600D**

Part No: 04111  
 6.0V/1200mAh VRLA - AGM  
 97 x 25 x 51 / 54.5mm  
 Weight: 310g

**US SURGICAL****Navigator Gamma Guidance System GG-0400-24 (send for rebuild)**

Part No: CSA22069  
 10.8V/3000mAh Ni-Cd  
 147 x 79 x 26mm  
 Weight: 770g

**VITALOGRAPH****Spirometer 2120 (older models up to 2009 - check battery type before ordering)**

Part No: EE050281  
 3.6V/800mAh Ni-Cd  
 44.2 x 15.4 x 49.2mm  
 Weight: 70g



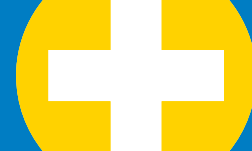

**WEINMANN**

**Accuvac Rescue**

Part No: EE140288  
12.0V/3000mAh Ni-Cd  
130 x 52 x 54mm  
Weight: 920g

CE 

**WELCH ALLYN** (also see PROPAQ / PROTOCOL)

**72000 Pocket Scope**

Part No: EE130011  
2.4V/700mAh Ni-Cd  
(Dia.x H): 26 x 59mm  
Weight: 75g

CE 

**WELCH ALLYN** (also see PROPAQ / PROTOCOL)

**300 / 5300P / 53000 Vital Signs Monitor / 530T0 / 530TP / 53S00 / 53S0P / 53ST0 / 53STP / 53N00 / 53NOP / 53NT0 / 53NTP**

Part No: EE400226  
6.0V/4000mAh VRLA - AGM  
74.5 x 52 x 108.5mm Weight: 880g

CE 

**WELCH ALLYN** (also see PROPAQ / PROTOCOL)

**72240 Indirect Ophthalmoscope**

Part No: EE120244  
4.8V/2000mAh Ni-Cd  
95 x 25 x 45mm  
Weight: 225g

CE 

**WELCH ALLYN** (also see PROPAQ / PROTOCOL)

**420 / 420TB / 4200B / 42MOB / 42MTB / 42NOB / 42NTB Series**

Part No: EE400220  
6.0V/4500mAh VRLA - AGM  
70 x 48 x 108mm  
Weight: 730g

CE 

**WELCH ALLYN** (also see PROPAQ / PROTOCOL)

**72250 LumiView**

Part No: EE120391  
3.6V/1900mAh Ni-Cd  
72 x 24 x 45mm  
Weight: 170g

CE 

**WELCH ALLYN** (also see PROPAQ / PROTOCOL)

**5200 / 52000 Vital Signs Monitor**

Part No: 400161  
6.0V/4500mAh VRLA - AGM  
70 x 48 x 108mm  
Weight: 735g

CE 

**WELCH ALLYN** (also see PROPAQ / PROTOCOL)

**72900 Microtyp 2**

Part No: EE070054  
2.4V/600mAh Ni-Cd  
17.5 x 17.5 x 58.6mm  
Weight: 40g

CE 

**WELCH ALLYN** (also see PROPAQ / PROTOCOL)

**62000 Atlas Monitor**

Part No: 04273  
6.0V/7200mAh VRLA - AGM  
151 x 34 x 94 / 100mm  
Weight: 1230g

CE 

**WELCH ALLYN** (also see PROPAQ / PROTOCOL)

**Audiometer AM232 / 72320**

Part No: EE120324  
7.2V/1900mAh Ni-Cd  
70 x 47 x 44mm  
Weight: 350g

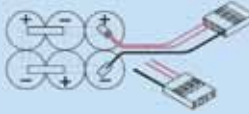
CE 

**WELCH ALLYN** (also see PROPAQ / PROTOCOL)

**71000-A / 71000-C / 71020-A / 71020-C / 71055-C / 72300 Ophthalmoscope**

Part No: EE130007  
3.6V/700mAh Ni-Cd  
(Dia.x H): 26 x 75mm  
Weight: 100g

CE 

**WELMED**

**P1000 / 2000 / 3000 / 4000 Syringe Pump**

Part No: 04112  
6.0V/2800mAh VRLA - AGM  
134 x 34 x 60.5 / 64mm  
Weight: 570g



**WELCH ALLYN** (also see PROPAQ / PROTOCOL)

**71144 / 71670 / 72200 / 72207 Halogen Ophthalmoscope**

Part No: 130005  
3.6V/700mAh Ni-Cd  
(Dia.x H): 26 x 75mm  
Weight: 95g

CE 

**ZOLL**

**PD1400 / 1600 / 1700 / 2000 / 4410 / M series Monitor/Defibrillator**

Part No: 02028  
10.0V/2500mAh VRLA - AGM  
192 x 70.7 x 39.5mm  
Weight: 1025g



**CYCLON****D Cell (0810-0004)**

Part No: 04000  
 2.0V/2500mAh VRLA - AGM  
 (Dia. x H): 34.3 x 68.1mm  
 Weight: 178g  
 Terminals (mm): 4.75 x 0.64 Tabs

**CYCLON****E Monobloc (0859-0010)**

Part No: 04036  
 4.0V/8000mAh VRLA - AGM  
 96.8 x 54.1 x 101.6mm  
 Weight: 960g  
 Terminals (mm): 6.35 x 0.64 Tabs

**CYCLON****DT Cell (0860-0004)**

Part No: 04006  
 2.0V/4500mAh VRLA - AGM  
 (Dia. x H): 34.3 x 102.9mm  
 Weight: 275g  
 Terminals (mm): 4.35 x 0.64 Tabs

**CYCLON****D Monobloc (0819-0012)**

Part No: 04011  
 6.0V/2500mAh VRLA - AGM  
 113.8 x 46 x 69.9mm  
 Weight: 520g  
 Terminals (mm): 4.75 x 0.64 Tabs

**CYCLON****X Cell (0800-0004)**

Part No: 04001  
 2.0V/5000mAh VRLA - AGM  
 (Dia. x H): 44.5 x 81.5mm  
 Weight: 362g  
 Terminals (mm): 6.35 x 0.64 Tabs

**CYCLON****X Monobloc (0809-0012)**

Part No: 04021  
 6.0V/5000mAh VRLA - AGM  
 139.2 x 53.8 x 76.7mm  
 Weight: 980g  
 Terminals (mm): 6.35 x 0.64 Tabs

**CYCLON****E Cell (0850-0004)**

Part No: 04005  
 2.0V/8000mAh VRLA - AGM  
 (Dia. x H): 44.5 x 108.7mm  
 Weight: 490g  
 Terminals (mm): 6.35 x 0.64 Tabs

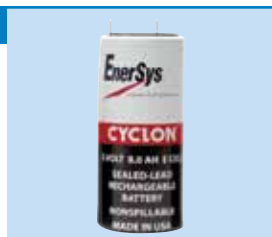
**CYCLON****E Monobloc (0859-0012)**

Part No: 04031  
 6.0V/8000mAh VRLA - AGM  
 139.2 x 54.1 x 101.6mm  
 Weight: 1430g  
 Terminals (mm): 6.35 x 0.64 Tabs

**CYCLON****BC Cell (0820-0004)**

Part No: 04003  
 2.0V/25Ah VRLA - AGM  
 (Dia. x H): 65.3 x 173.2mm  
 Weight: 1670g  
 Terminals (mm): M8+M6 Threaded Post

**EURO ENERGY****12v./2.3Ah VRLA**

Part No: 04231  
 12.0V/2300mAh VRLA - AGM  
 182 x 23 x 61mm  
 Weight: 750g Terminal: 11  
 (VJ1080 Mating Connector also available)

**CYCLON****D Monobloc (0819-0010)**

Part No: 04010  
 4.0V/2500mAh VRLA - AGM  
 79.5 x 46 x 69.9mm  
 Weight: 360g  
 Terminals (mm): 4.75 x 0.64 Tabs

**FIAMM****FG10301**

Part No: 04113  
 6.0V/3000mAh VRLA - AGM  
 134 x 34 x 60 / 67mm  
 Weight: 715g Terminal: 1A

**CYCLON****X Monobloc (0809-0010)**

Part No: 04020  
 4.0V/5000mAh VRLA - AGM  
 96.5 x 53.8 x 76.7mm  
 Weight: 740g  
 Terminals (mm): 6.35 x 0.64 Tabs

**FIAMM****FG20121**

Part No: 04257  
 12.0V/1200mAh VRLA - AGM  
 97 x 48.5 x 50.5 / 55mm  
 Weight: 600g Terminal: 4A



For battery layout and terminal information - see page 55



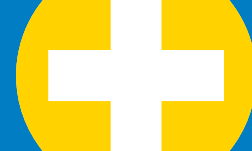

**FIAMM**  
**FG20121A**

Part No: 04272  
12.0V/1200mAh VRLA - AGM  
97 x 42 x 52 / 59mm  
Weight: 600g Terminal: 3A



**PANASONIC**  
**LC-R061R3PG**

Part No: 04226  
6.0V/1300mAh VRLA - AGM  
97 x 24 x 50 / 55mm  
Weight: 300g Terminal: 9A



**FIAMM**  
**FG20451**

Part No: 71013  
12.0V/4500mAh VRLA - AGM  
90 x 70 x 102 / 106mm  
Weight: 1580g Terminal: 1A



**PANASONIC**  
**LC-R062R4**

Obsolete - see part number 04204 (PS-628) page 47 for replacement battery



**FIAMM**  
**FG20721**

Part No: 04205  
12.0V/7200mAh VRLA - AGM  
151 x 65 x 94 / 99mm  
Weight: 2450g Terminal: 4A



**PANASONIC**  
**LC-063R2**

Obsolete - see part number 04202 (ES3.8-6) page 45 for replacement battery



**MK**  
**ES3.8-6**

Part No: 04202  
6.0V/3800mAh VRLA - AGM  
66 x 33 x 118 / 126mm  
Weight: 735g Terminal: 5A



**PANASONIC**  
**LC-R063R4P**

Part No: 04212  
6.0V/3400mAh VRLA - AGM  
134 x 34 x 60 / 66mm  
Weight: 620g Terminal: 9A



**MK**  
**ES2-12**

Part No: 04201  
12.0V/2000mAh VRLA - AGM  
201 x 25 x 61mm  
Weight: 724g Terminal: 10



**PANASONIC**  
**LC-R064R5P**

Part No: 04282  
6.0V/4500mAh VRLA - AGM  
70 x 48 x 102 / 108mm  
Weight: 720g Terminal: 9A



**MK**  
**ES2-12 V**

Part No: 04265  
12.0V/2000mAh VRLA - AGM  
143 x 23 x 64mm  
Weight: 590g Terminal: 11



**PANASONIC**  
**LC-R067R2PG**

Part No: 04273  
6.0V/7200mAh VRLA - AGM  
151 x 34 x 94 / 100mm  
Weight: 1230g Terminal: 1A



**MK**  
**ES3-12R**

Part No: 04271  
12.0V/3000mAh VRLA - AGM  
132 x 33 x 97 / 104mm  
Weight: 1160g Terminal: 1A



**PANASONIC**  
**LC-R0612PG**

Part No: 04232  
6.0V/12Ah VRLA - AGM  
151 x 50 x 94 / 100mm  
Weight: 2000g Terminal: 1A



**PANASONIC****LC-R121R3PG**

Part No: 04228  
 12.0V/1300mAh VRLA - AGM  
 97 x 47.5 x 50 / 55mm  
 Weight: 590g Terminal: 3A

**PANASONIC****LC-R127R2P1**

Part No: 04224  
 12.0V/7200mAh VRLA - AGM  
 151 x 64.5 x 94 / 100mm  
 Weight: 2470g Terminal: 4D

**PANASONIC****LC-S122AG**

Obsolete - see part number 04201  
 (ES2-12) page 45 for replacement  
 battery

**PANASONIC****LC-RA1212PG1**

Part No: 04211  
 12.0V/12Ah VRLA - AGM  
 151 x 98 x 94 / 100mm  
 Weight: 3800g Terminal: 4D

**PANASONIC****LC-R122R2PG**

Part No: 04200  
 12.0V/2200mAh VRLA - AGM  
 177 x 34 x 60 / 66mm  
 Weight: 800g Terminal: 1A

**PANASONIC****LC-XD1217PG**

Part No: 04235  
 12.0V/17Ah VRLA - AGM  
 181 x 76 x 167 mm  
 Weight: 6500g Terminal: 2F

**PANASONIC****LC-SA122R3AG**

Obsolete - see part number 04231  
 (12v./2.3Ah VRLA) page 44 for  
 replacement battery

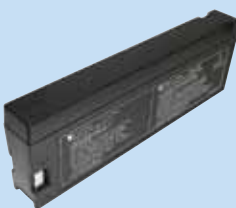
**PANASONIC****LC-P1220P**

Part No: 04247  
 12.0V/20Ah VRLA - AGM  
 181 x 76 x 167mm  
 Weight: 6600g Terminal: 2F

**PANASONIC****LC-R123R4PG**

Part No: 04233  
 12.0V/3400mAh VRLA - AGM  
 134 x 67 x 60 / 66mm  
 Weight: 1200g Terminal: 3A

**PANASONIC****LC-X1228AP**

Part No: 04220  
 12.0V/28Ah VRLA - AGM  
 165 x 125 x 175 / 179.5mm  
 Weight: 11kg Terminal: 2 & M5  
 threaded post

**PANASONIC****LC-R127R2PG**

Part No: 04274  
 12.0V/7200mAh VRLA - AGM  
 151 x 64.5 x 94 / 100mm  
 Weight: 2470g Terminal: 4A

**PANASONIC****LC-R1233P**

Part No: 04263  
 12.0V/33Ah VRLA - AGM  
 195.6 x 130 x 155 / 180mm  
 Weight: 12kg Terminal: 1G

**PANASONIC****LC-P127R2P1**

Part No: 04284  
 12.0V/7200mAh VRLA - AGM  
 151 x 64.5 x 94 / 100mm  
 Weight: 2470g Terminal: 4D

**PANASONIC****LC-P1275P**

Part No: 04203  
 12.0V/75Ah VRLA - AGM  
 350 x 166 x 175mm  
 Weight: 22kg Terminal: 2G



For battery layout and terminal information - see page 55

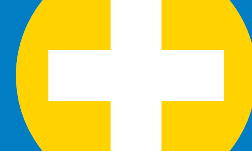

**PANASONIC**  
**UP-RW1220P1**

Part No: 04297  
 12.0V/20W Per Cell VRLA - AGM  
 140 x 38.5 x 94 / 101.5mm  
 Weight: 1350g Terminal: 4D



**PBQ**  
**PBQ4-12**

Part No: 04219  
 12.0V/4000mAh VRLA - AGM  
 195 x 47 x 70 / 74mm  
 Weight: 1700g Terminal: 1A



**PANASONIC**  
**UP-RWA1232P1**

Part No: 04292  
 12.0V/32W Per Cell VRLA - AGM  
 151 x 51 x 94 / 100mm  
 Weight: 2000g Terminal: 4D



**PORTALAC**  
**PX12026**

Part No: 04293  
 12.0V/2600mAh VRLA - AGM  
 178 x 34 x 60 / 66mm  
 Weight: 1000g Terminal: 4A



**PANASONIC**  
**UP-VW1245P**

Part No: 04287  
 12.0V/45W Per Cell VRLA - AGM  
 151 x 64.5 x 94 / 101.5mm  
 Weight: 2600g Terminal: 4D



**POWERSONIC**  
**PS-628**

Part No: 04204  
 6.0V/2900mAh VRLA - AGM  
 66 x 33 x 98 / 103mm  
 Weight: 590g Terminal: 8A



**PBQ**  
**PBQ3.2-6**

Part No: 04109  
 6.0V/3200mAh VRLA - AGM  
 134 x 34 x 61 / 67mm  
 Weight: 680g Terminal: 1A



**POWERSONIC**  
**PS-682**

Part No: 04227  
 6.0V/9000mAh VRLA - AGM  
 98 x 56 x 118 / 120mm  
 Weight: 1520g Terminal: 12A



**PBQ**  
**PBQ4.5-6**

Part No: 04294  
 6.0V/4500mAh VRLA - AGM  
 70 x 47 x 101 / 105mm  
 Weight: 850g Terminal: 5A



**POWERSONIC**  
**PS-6120FP**

Part No: 04290  
 6.0V/12Ah VRLA - AGM  
 108 x 71 x 141 / 141mm  
 Weight: 2250g Terminal: 23 (+=D/=-=A)



**PBQ**  
**PBQ1.3-12**

Part No: 04254  
 12.0V/1300mAh VRLA - AGM  
 98 x 48 x 52 / 57mm  
 Weight: 630g Terminal: 4A



**POWERSONIC**  
**PS-832**

Part No: 04278  
 8.0V/3200mAh VRLA - AGM  
 134 x 36 x 66 / 69mm  
 Weight: 860g Terminal: 3A



**PBQ**  
**PBQ2.9-12**

Part No: 04249  
 12.0V/2900mAh VRLA - AGM  
 79 x 56 x 99 / 102mm  
 Weight: 1180g Terminal: 2A



**POWERSONIC**  
**PS-1208**

Part No: 04276  
 12.0V/800mAh VRLA - AGM  
 96 x 25 x 62mm  
 Weight: 350g Terminal: 6I



**POWERSONIC****PS-1229**

Part No: 04216  
 12.0V/2900mAh VRLA - AGM  
 178 x 35 x 60 / 66mm  
 Weight: 1180g Terminal: 1A

**SONNENSCHN****A512/3.5S**

Part No: 04223  
 12.0V/3500mAh VRLA - Gel  
 134.5 x 66.8 x 60.5 / 64.4mm  
 Weight: 1500g Terminal: 19A

**POWERSONIC****PS-12350**

Part No: 04259  
 12.0V/35Ah VRLA - AGM  
 197 x 132 x 165 / 180mm  
 Weight: 11kg Terminal: 1G

**SONNENSCHN****A512/6.5S**

Part No: 04267  
 12.0V/6500mAh VRLA - Gel  
 151.7 x 65.5 x 94.5 / 98.4mm  
 Weight: 2600g Terminal: 20A

**SONNENSCHN****A506/1.2S**

Part No: 04208  
 6.0V/1200mAh VRLA - Gel  
 97.3 x 25.5 x 51 / 54.9mm  
 Weight: 330g Terminal: 15A

**SONNENSCHN****A512/10S**

Part No: 04248  
 12.0V/10Ah VRLA - Gel  
 152 x 98 x 94.5 / 98.4mm  
 Weight: 4000g Terminal: 21A

**SONNENSCHN****A506/3.5S**

Part No: 04215  
 6.0V/3500mAh VRLA - Gel  
 134.5 x 34.5 x 60.5 / 64.4mm  
 Weight: 750g Terminal: 15A

**SONNENSCHN****GF12033Y1**

Part No: 04214  
 12.0V/33Ah VRLA - Gel  
 210 x 175 x 175 / 210mm  
 Weight: 14.6kg Terminal: 22M

**SONNENSCHN****A208/2.7S**

Part No: 04255  
 8.0V/2700mAh VRLA - Gel  
 133.5 x 36.5 x 63 / 66.6mm  
 Weight: 780g Terminal: 16A

**YUASA****NP1-6**

Part No: 04110  
 6.0V/1000mAh VRLA - AGM  
 51 x 42.5 x 51 / 54.5mm  
 Weight: 250g Terminal: 5A

**SONNENSCHN****A508/3.5S**

Part No: 04242  
 8.0V/3500mAh VRLA - Gel  
 178.5 x 34.1 x 60.5 / 64.4mm  
 Weight: 1000g Terminal: 17A

**YUASA****NP1.2-6**

Part No: 04111  
 6.0V/1200mAh VRLA - AGM  
 97 x 25 x 51 / 54.5mm  
 Weight: 310g Terminal: 1A

**SONNENSCHN****A512/2.0S**

Part No: 04236  
 12.0V/2000mAh VRLA - Gel  
 178.5 x 34.1 x 60.5 / 64.4mm  
 Weight: 1000g Terminal: 18A

**YUASA****NP2.8-6**

Part No: 04112  
 6.0V/2800mAh VRLA - AGM  
 134 x 34 x 60.5 / 64mm  
 Weight: 570g Terminal: 1A





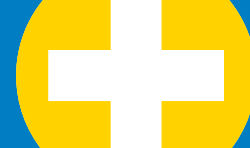

**YUASA**  
**NP4-6**

Part No: 04114  
6.0V/4000mAh VRLA - AGM  
70 x 47 x 102 / 105.5mm  
Weight: 870g Terminal: 5A



**YUASA**  
**NP2.1-12**

Part No: 04132  
12.0V/2100mAh VRLA - AGM  
178 x 34 x 60.5 / 64mm  
Weight: 960g Terminal: 1A



**YUASA**  
**NP7-6**

Part No: 04116  
6.0V/7000mAh VRLA - AGM  
151 x 34 x 94 / 97.5mm  
Weight: 1320g Terminal: 1A



**YUASA**  
**NP2.3-12**

Part No: 04138  
12.0V/2300mAh VRLA - AGM  
178 x 34 x 60.5 / 64mm  
Weight: 950g Terminal: 1A



**YUASA**  
**NP10-6**

Part No: 04118  
6.0V/10Ah VRLA - AGM  
151 x 50 x 94 / 97.5mm  
Weight: 1930g Terminal: 1A



**YUASA**  
**NP2.8-12**

Part No: 04134  
12.0V/2800mAh VRLA - AGM  
134 x 67 x 60.5 / 64mm  
Weight: 1200g Terminal: 3A



**YUASA**  
**NP12-6**

Part No: 04120  
6.0V/12Ah VRLA - AGM  
151 x 50 x 93.5 / 97.5mm  
Weight: 2050g Terminal: 1D



**YUASA**  
**NP2.9-12**

Obsolete - see part number 04249 (PBQ2.9-12) page 47 for replacement battery



**YUASA**  
**NP0.8-12**

Part No: 04130  
12.0V/800mAh VRLA - AGM  
96 x 25 x 61.5mm  
Weight: 350g Terminal: 6I



**YUASA**  
**NP3.2-12**

Part No: 04129  
12.0V/3200mAh VRLA - AGM  
134 x 67 x 60.5 / 64mm  
Weight: 1200g Terminal: 3A



**YUASA**  
**NP1.2-12**

Part No: 04131  
12.0V/1200mAh VRLA - AGM  
97 x 48 x 51 / 54.5mm  
Weight: 580g Terminal: 3A



**YUASA**  
**NP4-12**

Part No: 04135  
12.0V/4000mAh VRLA - AGM  
90 x 70 x 102.5 / 106mm  
Weight: 1750g Terminal: 1A



**YUASA**  
**NP1.2-12FR**

Part No: 04121  
12.0V/1200mAh VRLA - AGM  
97 x 48 x 51 / 54.5mm  
Weight: 580g Terminal: 3A



**YUASA**  
**NPH5-12 (High Rate)**

Part No: 04160  
12.0V/5000mAh VRLA - AGM  
90 x 70 x 102 / 106mm  
Weight: 2010g Terminal: 1D



**YUASA****NP7-12**

Part No: 04137  
 12.0V/7000mAh VRLA - AGM  
 151 x 65 x 94 / 97.5mm  
 Weight: 2790g Terminal: 4A

**YUASA****NP38-12**

Part No: 04141  
 12.0V/38Ah VRLA - AGM  
 197 x 165 x 170mm  
 Weight: 14.2kg Terminal: 2J\*

\*Converter to Terminal Type E Available

**YUASA****NP7-12FR (Flame Retardant)**

Part No: 04154  
 12.0V/7000mAh VRLA - AGM  
 151 x 65 x 94 / 97.5mm  
 Weight: 2700g Terminal: 4A

**YUASA****NP65-12**

Part No: 04142  
 12.0V/65Ah VRLA - AGM  
 350 x 166 x 174mm  
 Weight: 23kg Terminal: 2K

**YUASA****NP7-12L**

Part No: 04174  
 12.0V/7000mAh VRLA - AGM  
 151 x 65 x 94 / 97.5mm  
 Weight: 2650g Terminal: 4D

**YUASA****NPC24-12 I (Cyclic Series)**

Part No: 04145  
 12.0V/24Ah VRLA - AGM  
 166 x 175 x 125mm  
 Weight: 8800g Terminal: 2J\*

\*Converter to Terminal Type E Available

**YUASA****NP12-12**

Part No: 04128  
 12.0V/12Ah VRLA - AGM  
 151 x 98 x 93.5 / 97.5mm  
 Weight: 4090g Terminal: 4D

**YUASA****NPC38-12 I (Cyclic Series)**

Part No: 04146  
 12.0V/38Ah VRLA - AGM  
 197 x 165 x 170mm  
 Weight: 14.2kg Terminal: 2J\*

\*Converter to Terminal Type E Available

**YUASA****NP17-12**

Part No: 04139  
 12.0V/17Ah VRLA - AGM  
 181 x 76 x 167mm  
 Weight: 6100g Terminal: 2J

**YUASA****NPC65-12 I (Cyclic Series)**

Part No: 04153  
 12.0V/65Ah VRLA - AGM  
 350 x 166 x 174mm  
 Weight: 23kg Terminal: 2K

**YUASA****NP18-12B**

Part No: 04162  
 12.0V/17.2Ah VRLA - AGM  
 180 x 76 x 167mm  
 Weight: 6210g Terminal: 2E

**YUASA****NPL24-12 I (Standby Long Life)**

Part No: 04140  
 12.0V/24Ah VRLA - AGM  
 175 x 166 x 125mm  
 Weight: 9000g Terminal: 2J\*

\*Converter to Terminal Type E Available

**YUASA****NP24-12**

Obsolete - See part number 04140  
 (NPL24-12 I) page 50 for replacement  
 battery

**YUASA****NPL24-12 I FR (Standby Long Life & Flame Retardant)**

Part No: 71034  
 12.0V/24Ah VRLA - AGM  
 175 x 166 x 125mm  
 Weight: 8800g Terminal: 2J\*

\*Converter to Terminal Type E Available



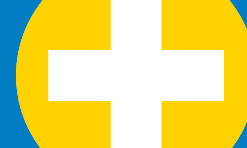

**YUASA**  
**NPL38-12 I (Standby Long Life)**  
 Part No: 04171  
 12.0V/38Ah VRLA - AGM  
 197 x 165 x 170mm  
 Weight: 14.5kg Terminal: 2J\*

\*Converter to Terminal Type E Available



**YUASA**  
**YPC26-12 (Cyclic Series)**  
 Part No: 04188  
 12.0V/26Ah VRLA - AGM  
 166.5 x 175 x 126mm  
 Weight: 8600g Terminal: 2J



**YUASA**  
**NPL65-12 I (Standby Long Life)**  
 Part No: 04172  
 12.0V/65Ah VRLA - AGM  
 350 x 166 x 174mm  
 Weight: 23.8kg Terminal: 2K



**YUASA**  
**YPC30-12 (Cyclic Series)**  
 Part No: 04189  
 12.0V/30Ah VRLA - AGM  
 195 x 130 x 164 / 180mm  
 Weight: 9300g Terminal: 1G



**YUASA**  
**NPL78-12 I FR (Standby Long Life & Flame Retardant)**  
 Part No: 71016  
 12.0V/78Ah VRLA - AGM  
 380 x 166 x 174mm  
 Weight: 27.5kg Terminal: 2L



**YUASA**  
**YPC33-12 (Cyclic Series)**  
 Part No: 04184  
 12.0V/33Ah VRLA - AGM  
 195 x 130 x 164 / 167mm  
 Weight: 11.2kg Terminal: 1K



**YUASA**  
**NPL100-12 (Standby Long Life)**  
 Part No: 04175  
 12.0V/100Ah VRLA - AGM  
 407 x 172 x 240mm  
 Weight: 39kg Terminal: 1E



**YUASA**  
**YPC45-12 (Cyclic Series)**  
 Part No: 04190  
 12.0V/45Ah VRLA - AGM  
 197 x 165 x 170mm  
 Weight: 14.5kg Terminal: 2K



**YUASA**  
**YPC8-12 (Cyclic Series)**  
 Part No: 04186  
 12.0V/8000mAh VRLA - AGM  
 152 x 65.5 x 94.5 / 100mm  
 Weight: 2800g Terminal: 4A



**YUASA**  
**YPC55-12 (Cyclic Series)**  
 Part No: 04191  
 12.0V/55Ah VRLA - AGM  
 229 x 138 x 205 / 211mm  
 Weight: 17kg Terminal: 1K



**YUASA**  
**YPC14-12 (Cyclic Series)**  
 Part No: 04187  
 12.0V/14Ah VRLA - AGM  
 151 x 98 x 95 / 101mm  
 Weight: 4200g Terminal: 4D



**YUASA**  
**YPC75-12 (Cyclic Series)**  
 Part No: 04192  
 12.0V/75Ah VRLA - AGM  
 259 x 168 x 208 / 214mm  
 Weight: 25kg Terminal: 1K



**YUASA**  
**YPC22-12 (Cyclic Series)**  
 Part No: 04183  
 12.0V/22Ah VRLA - AGM  
 181.5 x 77 x 166.5mm  
 Weight: 6900g Terminal: 2J



**YUASA**  
**YPC100-12 (Cyclic Series)**  
 Part No: 04193  
 12.0V/100Ah VRLA - AGM  
 330 x 173 x 212 / 220mm  
 Weight: 30kg Terminal: 1L



**DURACELL****AAA Procell MN2400 LR03**

Part No: 50053  
 1.5V Alkaline  
 (Dia.x H): 10.5 x 44.5mm  
 Weight: 12g

**GP****GP700DHC D Battery**

Part No: 01702  
 1.2V/7000mAh Ni-MH  
 (Dia.x H): 34.2 x 61.5mm  
 Weight: 155g

**DURACELL****C Procell MN1400 LR14**

Part No: 50051  
 1.5v Alkaline  
 (Dia.x H): 26 x 50mm  
 Weight: 70g

**GP****LR1 N**

Part No: 50004  
 1.5V Alkaline  
 (Dia.x H): 12 x 30.2mm  
 Weight: 12g

**DURACELL****CR1/3N**

Part No: 50800  
 3.0V/190mAh Lithium Primary  
 (Dia.x H): 11.6 x 10.8mm  
 Weight: 3g

**MAXEL****CR1220 Coin Cell**

Part No: 50304  
 3.0V Lithium Primary  
 (Dia.x H): 12.5 x 2mm  
 Weight: 2g

**GP****GP17R8H PP3 Battery**

Part No: 03114  
 8.4V/170mAh Ni-MH  
 15.7 x 26.5 x 48.5mm  
 Weight: 32g

**PANASONIC****AA Powerline LR6**

Part No: 50002  
 1.5v Alkaline  
 (Dia.x H): 14.5 x 50.5mm  
 Weight: 30g

**GP****GP100AAHC AAA Battery**

Part No: 00218  
 1.2V/1000mAh Ni-MH  
 (Dia.x H): 10.5 x 44.5mm  
 Weight: 15.2g

**PANASONIC****AAA Powerline LR03**

Part No: 50003  
 1.5v Alkaline  
 (Dia.x H): 10.5 x 44.5mm  
 Weight: 14g

**GP****GP210AAHCB-C4 ReCyKo**

Part No: 00552  
 1.2V/2100mAh Ni-MH  
 (Dia.x H): 14.5 x 50.5mm  
 Weight: 28g

**PANASONIC****BR2/3A**

Part No: 50900  
 3.0V/5000mAh Lithium Primary  
 (Dia.x H): 17 x 33.5mm  
 Weight: 14g

**GP****GP350CHC C Battery**

Part No: 01423  
 1.2V/3500mAh Ni-MH  
 (Dia.x H): 26.2 x 50mm  
 Weight: 79g

**PANASONIC****BR A**

Part No: 50901  
 3.0V/1800mAh Lithium Primary  
 (Dia.x H): 17 x 45.5mm  
 Weight: 18g





Please note that brands and pack sizes supplied may change from time to time according to availability. Please check upon ordering.

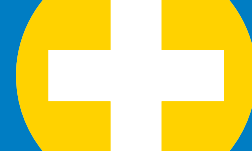





<b>PANASONIC</b>	
<p><b>CR123A / CR17345</b></p> <p>Part No: 50702 3.0V/1400mAh Lithium Primary (Dia.x H): 17 x 34.5mm Weight: 17g</p>	

<b>PANASONIC</b>	
<p><b>PP3 Powerline 6LR61</b></p> <p>Part No: 50100 9.0v. Alkaline 26.5 x 16.4 x 48.5mm Weight: 50g</p>	

<b>PANASONIC</b>	
<p><b>CR2016 Coin Cell</b></p> <p>Part No: 50310 3.0V Lithium Primary (Dia.x H): 20 x 1.6mm Weight: 2g</p>	

<b>PANASONIC</b>	
<p><b>VL2320/IVC Coin Cell*</b></p> <p>Part No: 03012 3.0V Lithium Primary (Dia.x H): 23 x 2.6mm Weight: 2g</p>	

<b>PANASONIC</b>	
<p><b>CR2025 Coin Cell</b></p> <p>Part No: 50311 3.0V Lithium Primary (Dia.x H): 20 x 2.5mm Weight: 3g</p>	

<b>SANYO</b>	
<p><b>CR12600SE / CR2NP</b></p> <p>Part No: 50802 3.0V/1400mAh Lithium Primary (Dia.x H): 12 x 60.4mm Weight: 13g</p>	

<b>PANASONIC</b>	
<p><b>CR2032 Coin Cell</b></p> <p>Part No: 50312 3.0V Lithium Primary (Dia.x H): 20 x 3.2mm Weight: 3g</p>	

<b>ULTRALIFE</b>	
<p><b>U9VL FP</b></p> <p>Part No: 50110 9.0V Lithium Primary 26.5 x 17.5 x 49.2mm Weight: 36g</p>	

<b>PANASONIC</b>	
<p><b>CR3032 Coin Cell</b></p> <p>Part No: 50322 3.0V Lithium Primary (Dia.x H): 30 x 3.2mm Weight: 7g</p>	

<b>VARTA</b>	
<p><b>LR20 D</b></p> <p>Part No: 50024 1.5v. Alkaline (Dia.x H): 34 x 61mm Weight: 141g</p>	

<b>PANASONIC</b>	
<p><b>LR44</b></p> <p>Part No: 50202 1.5V Alkaline (Dia.x H): 11.6 x 5.4mm Weight: 2g</p>	

<b>PANASONIC</b>	
<p><b>P18N</b></p> <p>Part No: 01911 1.2V Ni-Cd (Dia.x H): 12 x 30mm Weight: 8g</p>	

Please note that brands and pack sizes supplied may change from time to time according to availability. Please check upon ordering.

### CHECKMATE TEST UNIT / POWER SUPPLY

**Upgrade Checkmate II to Checkmate III**  
Part No: 70006  
**Checkmate III Test Unit**  
Part No: 04957  
**Checkmate III Power Supply**  
Part No: 04956



### CHECKMATE PRINTER / PAPER

**Checkmate II/III Printer Type ETP1**  
Part No: 04958  
**Checkmate Thermal Printer Paper - 10 Rolls**  
**PTP1 for ETP1 Printer 50mm wide** Part No: 04951  
**Checkmate Thermal Printer Paper - 10 Rolls**  
**for ETP Printer 110mm wide** Part No: 04960



### CHECKMATE III RECALIBRATION

**Recalibration of Checkmate III Test Unit**  
**Only. Comes with Calibration Certificate**  
Part No: 70005  
**Recalibration of Checkmate III Test Unit,**  
**Checking Safety of Power Supply.**  
**Comes with Calibration Certificate**  
Part No: 70004



### CHARGER

**9641-6/2.5 UK Plug Top Charger**  
Part No: 04984  
Voltage: 6.0V Output: 2.5A  
Battery Capacities: 5.0 - 24.0Ah



### CHARGER

**9641-12/1.0 UK Plug Top Charger**  
Part No: 04968  
Voltage: 12.0V Output: 1.0A  
Battery Capacities: 2.3 - 5.0Ah



### CHARGER

**9641-12/2.7 UK Plug Top Charger**  
Part No: 04985  
Voltage: 12.0V Output: 2.7A  
Battery Capacities: 5.0 - 24.0Ah



### CHARGER

**2040-12/4.0 Bench Top Charger**  
Part No: 04993  
Voltage: 12.0V Output: 4.0A  
Battery Capacities: 12.0 - 48.0Ah



### CHARGER

**9740-12/10.0 Bench Top Charger**  
Part No: 04990  
Voltage: 12.0V Output: 10.0A  
Battery Capacities: 38.0 - 100.0Ah



### CHARGER

**2040-24/2.0 Bench Top Charger**  
Part No: 04987  
Voltage: 24.0V Output: 2.0A  
Battery Capacities: 5.0 - 12.0Ah



### CHARGER

**9740-24/5.0 Bench Top Charger**  
Part No: 04970  
Voltage: 24.0V Output: 5.0A  
Battery Capacities: 12.0 - 48.0Ah



### CHARGER

**LCS122AG / LCSD122PG /**  
**LCSA122R3AG/ LCTA121R9PG VRLA**  
**Plug Top Charger**  
Part No: EE460034  
Voltage: 12.0V  
Battery Capacities: 2.0 - 2.3Ah



### CHARGER

**Twin Bench Top LCSA122R3AG VRLA**  
**Charger**  
Part No: 04952  
Voltage: 12.0V  
Battery Capacities: 2.0 - 2.3Ah



### SINGLE CELL CHARGER

**For Rechargeable Batteries**  
Part No: 04912  
Plug in type single cell charger includes  
4 x Ansmann 2400 Batteries, suitable for  
Ni-MH, has safety timer, fast charges  
1-4 AA/AAA & charges PP3 batteries.  
Detects when fully charged.



### Charger Notes:

On Bench Top and UK plug top chargers, multi-stage charging sequence approved to give maximum service life in all SLA batteries. Orange LED indicates bulk charge, green LED indicates ready for use.

Checkmate III can be used for Ni-Cd, Ni-MH, VRLA, Cyclon and Li-ion Batteries.

Checkmate III allows data to be exported to PC.

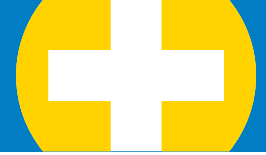

# Battery Terminal & Layout Information

## Terminals

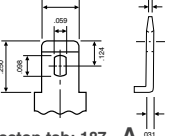
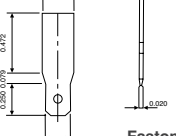
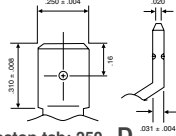
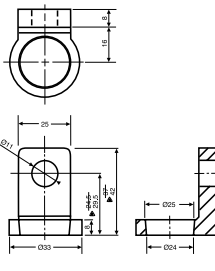
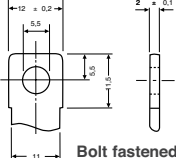
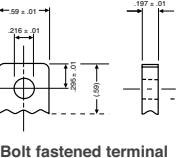
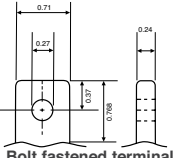
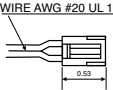
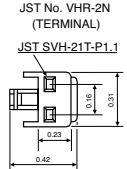
 <p><b>Faston tab: 187 A</b></p> <table border="1"> <thead> <tr> <th colspan="2">INCH = MM</th> </tr> </thead> <tbody> <tr><td>.250</td><td>6.35</td></tr> <tr><td>.185</td><td>4.70</td></tr> <tr><td>.124</td><td>3.15</td></tr> <tr><td>.098</td><td>2.50</td></tr> <tr><td>.059</td><td>1.50</td></tr> <tr><td>.031</td><td>0.80</td></tr> <tr><td>.020</td><td>0.50</td></tr> <tr><td>.004</td><td>0.10</td></tr> </tbody> </table>	INCH = MM		.250	6.35	.185	4.70	.124	3.15	.098	2.50	.059	1.50	.031	0.80	.020	0.50	.004	0.10	 <p><b>Faston tab: 187 B</b></p> <table border="1"> <thead> <tr> <th colspan="2">INCH = MM</th> </tr> </thead> <tbody> <tr><td>0.472</td><td>12.00</td></tr> <tr><td>0.250</td><td>6.35</td></tr> <tr><td>0.236</td><td>6.00</td></tr> <tr><td>0.185</td><td>4.70</td></tr> <tr><td>0.079</td><td>2.00</td></tr> <tr><td>0.020</td><td>0.50</td></tr> </tbody> </table>	INCH = MM		0.472	12.00	0.250	6.35	0.236	6.00	0.185	4.70	0.079	2.00	0.020	0.50	 <p><b>Faston tab: 250 D</b></p> <table border="1"> <thead> <tr> <th colspan="2">INCH = MM</th> </tr> </thead> <tbody> <tr><td>.310</td><td>7.90</td></tr> <tr><td>.250</td><td>6.35</td></tr> <tr><td>.16</td><td>4.0</td></tr> <tr><td>.031</td><td>0.8</td></tr> <tr><td>.020</td><td>0.5</td></tr> </tbody> </table>	INCH = MM		.310	7.90	.250	6.35	.16	4.0	.031	0.8	.020	0.5	 <p><b>Internal thread terminal</b></p> <table border="1"> <thead> <tr> <th>Terminal</th> <th>x</th> <th>y</th> </tr> </thead> <tbody> <tr><td><b>J:</b></td><td>17mm</td><td>M5</td></tr> <tr><td><b>K:</b></td><td>20mm</td><td>M6</td></tr> <tr><td><b>L:</b></td><td>20mm</td><td>M8</td></tr> </tbody> </table> <p><b>Terminal M</b></p>	Terminal	x	y	<b>J:</b>	17mm	M5	<b>K:</b>	20mm	M6	<b>L:</b>	20mm	M8
INCH = MM																																																											
.250	6.35																																																										
.185	4.70																																																										
.124	3.15																																																										
.098	2.50																																																										
.059	1.50																																																										
.031	0.80																																																										
.020	0.50																																																										
.004	0.10																																																										
INCH = MM																																																											
0.472	12.00																																																										
0.250	6.35																																																										
0.236	6.00																																																										
0.185	4.70																																																										
0.079	2.00																																																										
0.020	0.50																																																										
INCH = MM																																																											
.310	7.90																																																										
.250	6.35																																																										
.16	4.0																																																										
.031	0.8																																																										
.020	0.5																																																										
Terminal	x	y																																																									
<b>J:</b>	17mm	M5																																																									
<b>K:</b>	20mm	M6																																																									
<b>L:</b>	20mm	M8																																																									
 <p><b>Bolt fastened terminal E</b></p> <table border="1"> <thead> <tr> <th colspan="2">INCH = MM</th> </tr> </thead> <tbody> <tr><td>.472</td><td>12.00</td></tr> <tr><td>.453</td><td>11.50</td></tr> <tr><td>.433</td><td>11.00</td></tr> <tr><td>.216</td><td>5.50</td></tr> <tr><td>.079</td><td>2.00</td></tr> </tbody> </table>	INCH = MM		.472	12.00	.453	11.50	.433	11.00	.216	5.50	.079	2.00	 <p><b>Bolt fastened terminal F</b></p> <table border="1"> <thead> <tr> <th colspan="2">INCH = MM</th> </tr> </thead> <tbody> <tr><td>.59</td><td>15.0</td></tr> <tr><td>.216</td><td>5.5</td></tr> <tr><td>.295</td><td>7.5</td></tr> <tr><td>.197</td><td>5.0</td></tr> </tbody> </table>	INCH = MM		.59	15.0	.216	5.5	.295	7.5	.197	5.0																																				
INCH = MM																																																											
.472	12.00																																																										
.453	11.50																																																										
.433	11.00																																																										
.216	5.50																																																										
.079	2.00																																																										
INCH = MM																																																											
.59	15.0																																																										
.216	5.5																																																										
.295	7.5																																																										
.197	5.0																																																										
 <p><b>Bolt fastened terminal G</b></p> <table border="1"> <thead> <tr> <th colspan="2">INCH = MM</th> </tr> </thead> <tbody> <tr><td>0.24</td><td>6</td></tr> <tr><td>0.27</td><td>7</td></tr> <tr><td>0.37</td><td>9.5</td></tr> <tr><td>0.71</td><td>18</td></tr> <tr><td>0.768</td><td>19.5</td></tr> </tbody> </table>	INCH = MM		0.24	6	0.27	7	0.37	9.5	0.71	18	0.768	19.5	<p><b>JST No. VHR-2N I</b> WIRE AWG #20 UL 1007</p>  <p><b>JST No. VHR-2N (TERMINAL)</b> <b>JST SVH-21T-P1.1</b></p> 																																														
INCH = MM																																																											
0.24	6																																																										
0.27	7																																																										
0.37	9.5																																																										
0.71	18																																																										
0.768	19.5																																																										

## Layouts

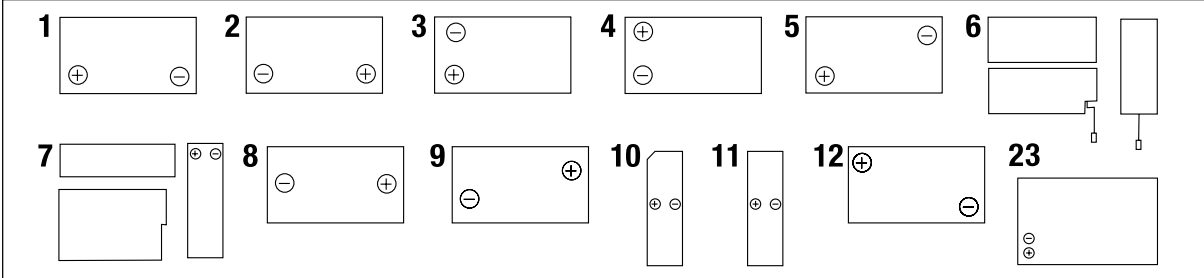

1 2 3 4 5 6  
7 8 9 10 11 12 23

## Terminals/Layouts - Sonnenschein

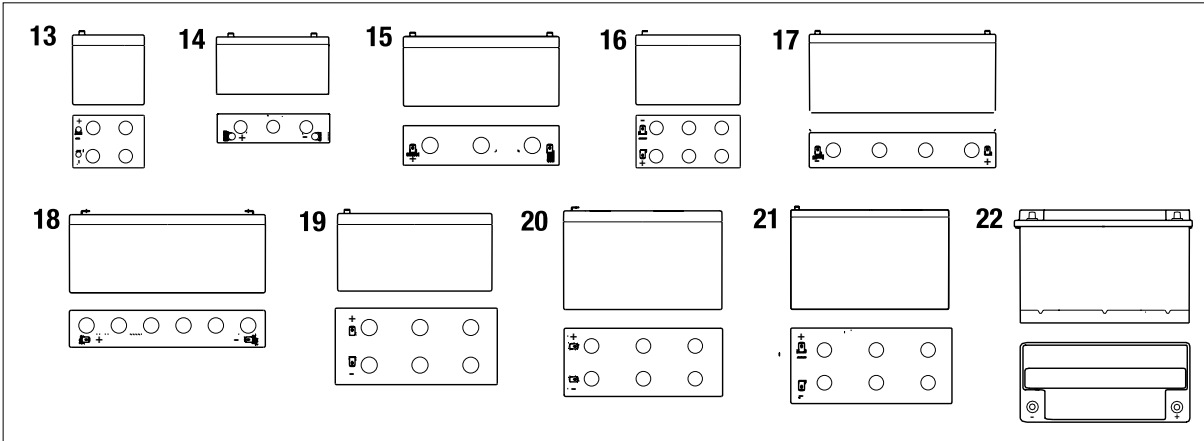

13 14 15 16 17  
18 19 20 21 22

# Index

## Replacement Batteries

3M	3	GOULD	20	QUEST MEDICAL	36
ABBOTT LABORATORIES / HOSPIRA / ROSS	3	GRASEBY	20	RADIOMETER	36
ABBOTT POINT OF CARE INC.	4	GRAYSTAD	21	REFLOLUX	37
AEROPEN	4	HAEMOCUE	21	REMED	37
AEROSOL PRODUCTS / MG ELECTRIC	4	HEMOCHRON	21	RESPIRONICS	37
AIR SHIELDS	4	HEINE	21	RIGEL MEDICAL	37
AIROX	4	HELLIGE GMBH	22	RSL STEEPER	37
ALCON	4	HEWLETT PACKARD / PHILIPS	22	S&W	37
AMEDA	4	HME	23	SCALE-TRONIX INC.	38
A&D	4	HORWELL	24	SCHILLER	38
ARCOMED	5	HUNTLEIGH	24	SECA	38
ARJO	5	IMED	24	SEWARD MEDICAL	39
ASPECT MEDICAL SYSTEMS	5	IMEX MEDICAL SYSTEMS	24	SHERWOOD MED. / AMERICAN HOSP. SUPPLIES	39
ASTROMED	5	IMPACT MEDICAL	25	SIEMENS / BURDICK	39
ATMOS	6	INFRASONICS	25	SMITHS MEDICAL / MEDEX	40
B.BRAUN	6	INNOMED	25	SONICAID MEDICAL	40
BARD	6	INVACARE	25	SPACELABS MEDICAL	40
BAXTER	7	IN-VIVO RESEARCH INC.	25	STRYKER	41
BCI INTERNATIONAL	7	KCI MEDICAL	25	SUNRISE MEDICAL	41
BLEASE	7	KEELER OPTICAL / SITE MICRO SURGICAL	26	SUZUKEN KENZ	41
BREAS MEDICAL	8	KONTRON (ROCHE)	26	TALLEY GROUP LIMITED	41
BURDICK	8	KOWA	27	TENSCARE LIMITED	41
CAMBRIDGE INST.	9	LAERDAL	27	TERUMO	41
CAMINO LABORATORIES	9	LIFECARE	28	THORATEC CORPORATION	41
CARDIET	9	LIKO / HILLROM	28	TOBY CHURCHILL LTD	41
CARDIO RAPID	9	M D E	28	TRIMED CORP.	42
CARDIOLINE	9	MANGAR INTERNATIONAL	28	US SURGICAL	42
CAREFUSION	9	MARSDEN	28	VIASYS HEALTHCARE INC.	42
CAS MEDICAL SYSTEMS INC.	11	MAQUET	28	VICKERS	42
CLINICAL DYNAMICS CORPORATION	11	MASIMO	29	VIOMEDIX	42
CME	11	MEDELA	29	VITALOGRAPH	42
CODAN	11	MEDICAL DIAGNOSTIC EQUIPMENT	29	WEINMANN	43
COLIN MEDICAL INSTRUMENTS	11	MEDIWATCH	29	WELCH ALLYN	43
CONMED / LINVATEC / HALL	11	MEDIX INFUSION SYSTEMS	29	WELMED	43
COROMETRICS MEDICAL SYSTEMS	11	MEDLAB	29	ZOLL	43
COW & GATE	11	MEG	29		
COVIDIEN	11	MINOLTA	29		
CRITICARE SYSTEM INC.	13	MIRAGE HEALTH GROUP LIMITED	30	<b>Sealed Lead Acid Batteries</b>	
DAMECA	14	MOLIFT	30	CYCLON	44
DATASCOPE / MINDRAY	14	NESSBITT & EVANS	30	EURO ENERGY	44
DATEX	14	NIHON KOHDEN	30	FIAMM	44
DATREND SYSTEM	15	NIKKISO	31	MK	45
DELFI MEDICAL INNOVATIONS INC.	15	NONIN MEDICAL	31	PANASONIC	45
DELFI MEDICAL SYSTEMS	15	NOVAMETRIX MEDICAL	31	PBQ	47
DENTSPLY INTERNATIONAL	16	NUEROCONTROL CORP.	32	PORTALAC	47
DEVILBISS HEALTHCARE	16	OHMEDA MEDICAL PRODUCTS	32	POWERSONIC	47
DEWERT	16	OMRON HEALTHCARE	33	SONNENSCHEN	48
DIAGNOSTIC ULTRASOUND CORP.	16	OSCAR BOSCAROL	33	YUASA	48
DRAEGER	16	OTODYNAMICS	33		
DYNATECH / NEVADA	17	OXYLITRE	33	<b>Primary &amp; Rechargeable Batteries</b>	
EAST RADCLIFFE	17	PACETECH	33	DURACELL	52
ELMED	17	PALCO LABORATORIES	33	GP	52
EMS PHYSIO LIMITED	17	PARI MEDICAL	33	MAXEL	52
ENGSTROM	17	PARKS ELECTRONICS LABS	33	PANASONIC	52
ESAOTE	17	PEGASUS	34	SANYO	53
ESCHMANN	17	PETERS	34	ULTRALIFE	53
FERNO	17	PHILIPS	34	VARTA	53
FIBRE OPTIC MEDICAL	17	PHILIPS RESPIRONICS	34		
FLAEM NUOVA	18	PHYSIO CONTROL	34	<b>Chargers &amp; Testers</b>	
FRESENIUS	18	POSSUM LIMITED	35	CHECKMATE	54
FUKUDA DENSHI	18	PROPAQ / PROTOCOL	36	EURO ENERGY	54
FUKUDA ME	18	PULMONETICS	36		
GE HEALTHCARE	18	PURITAN BENNETT	36		



**BATTERIES FOR:**

**DEFIBRILLATORS**

**VENTILATORS**

**MONITORS**

**OPHTHALMOSCOPES**

**NEBULISERS**

**ULTRASOUND  
MACHINES**

**AEDS**

**PULSE OXIMETERS**

**SYRINGE PUMPS**

**HOISTS**

**MEDICAL SAWS**

**SUCTION PUMPS**

**MEDICAL DRILLS**

**AND MORE...**